

# Mechanical Efficiency of Differential Gearing

D. Yu  
N. Beachley  
University of Wisconsin  
Madison, Wisconsin

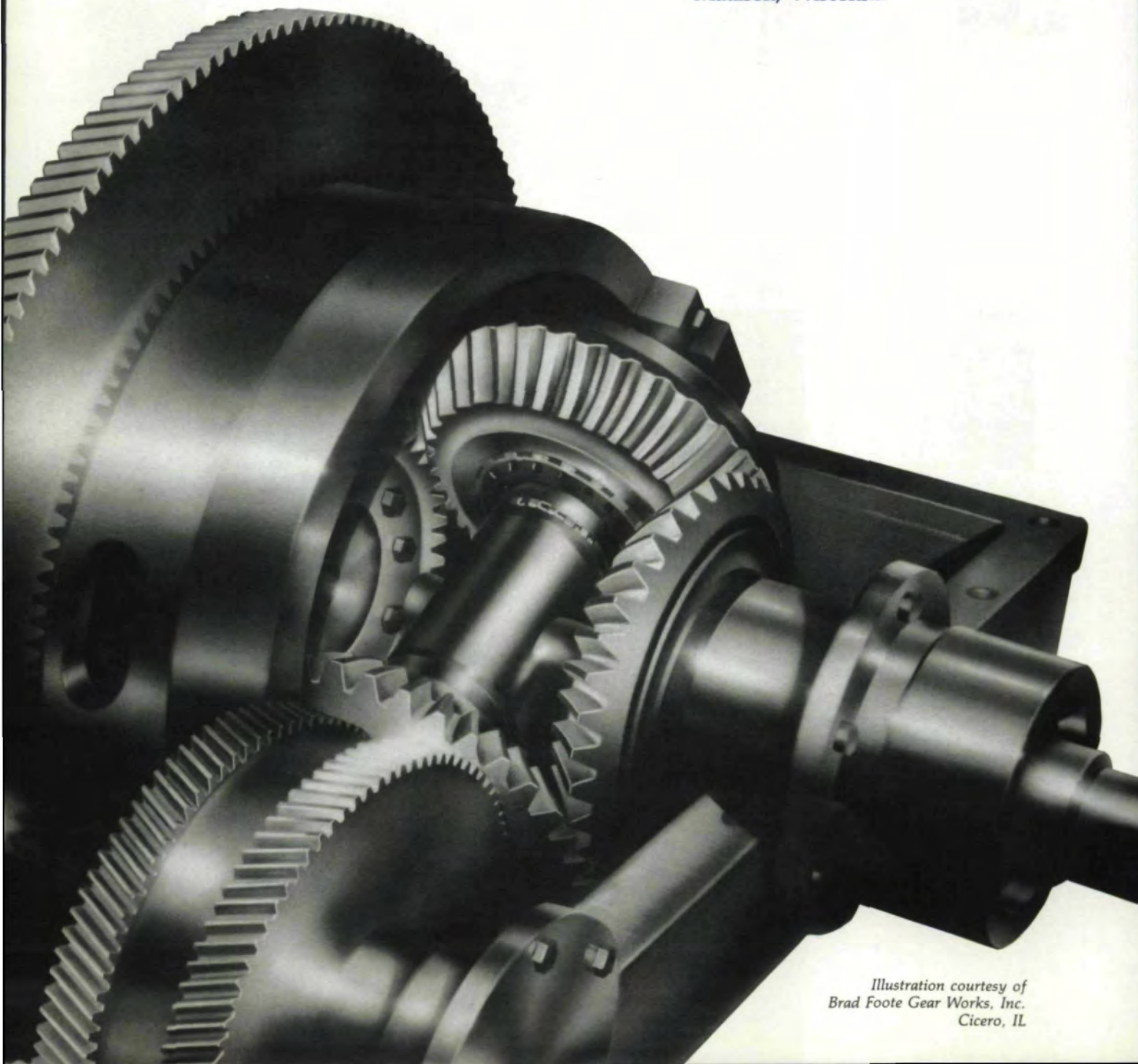

*Illustration courtesy of  
Brad Foote Gear Works, Inc.  
Cicero, IL*

## Introduction

Mechanical efficiency is an important index of gearing, especially for epicyclic gearing. Because of its compact size, light weight, the capability of a high speed ratio, and the ability to provide differential action, epicyclic gearing is very versatile, and its use is increasing. However, attention should be paid to efficiency not only to save energy, but sometimes also to make the transmission run smoothly or to avoid a self-locking condition. For example, a Continuously Variable Transmission (CVT) is attractive for motor vehicles (and especially for flywheel or other energy storage hybrid vehicles), but most types of CVT have poor efficiency, and the energy loss of a vehicular CVT can be comparable to the road load energy.<sup>(1)</sup> The split-path or bifurcated power transmission is one promising type of CVT, consisting in some cases of differential gearing and a traction drive used to change the speed ratio continuously (Fig. 1). It is convenient to call the latter a Continuously Variable Unit (CVU) to differentiate it from the overall CVT system. Traction drive systems have a significant loss through slip and creep; therefore, it is important to reduce the amount of power flowing through the CVU as much as possible; and many studies concerning this problem have been done.<sup>(2-6)</sup> In most of them, however, the efficiency of the differential has not been taken into account, consequently the calculated overall efficiencies will not match those of a real system, and in some cases may be quite different. It is not practical to use an average value of efficiency either, because unlike conventional gearing, the efficiency of differential gearing is very sensitive to changes in speed ratio.

A common method for calculating the efficiency of epicyclic gearing is the so-called "latent power" or "gearing power" method. Although the name of the method and the procedure of deriving the formulas are somewhat different in some articles, the derived formulas are similar.<sup>(7-11)</sup> In most articles, however, emphasis has not been given to the differential, which has more than one degree of freedom, but instead given to planetary gearing that has only one degree of freedom and is simpler to analyze. Therefore, it is important to develop an explicit and general method for calculating the efficiency of differential gearing.

## AUTHORS:

**DR. DAVID YU** is a Consulting Engineer for Reliance Electric Co. Since 1982 he has been an Honorary Fellow of the University of Wisconsin at Madison. In the academic arena, he has served as the Deputy Head of the Mechanical Engineering Department, and as Professor of Machine Design at a Chinese University. Professor Yu is the author of numerous articles on gearing. He is a member of CMES and JSME.

**DR. NORMAN BEACHLEY** teaches undergraduate courses in the mechanical design area and graduate level courses in fluid power and analysis and design of rotating machinery. He is coauthor of the textbook *Introduction to Dynamic System Analysis*.

His current research includes microprocessor control of internal combustion engines/hydrostatic transmission systems. He is also investigating the efficiency characteristics of various types of split-path, continuously variable transmissions.

A new project is to study novel internal combustion engine designs with greatly reduced mechanical friction.

## General Considerations and Definitions

It is necessary and important to provide some precise and accurate definitions, otherwise confusion and mistakes are liable to occur.

**Fundamental Differential.** A fundamental differential has three basic members that can input or output power, including the carrier (Fig. 2). Without a carrier, there is no differential, so the carrier is an important member and is symbolized as  $H$ . Strictly speaking, a fundamental differential has two degrees of freedom, i.e., two constraints must be given, otherwise the relationships among the three members are independent. For example, if two of the three members are given as inputs, then the other can be determined as the output. It is also possible to have one input and two outputs, and knowing any two values makes it possible to calculate the third. The fundamental differential is the most common one, and types with more than two degrees of freedom are seldom used; thus, in this article the study is restricted to the fundamental differential.

**Speed Ratio.** The angular speed ratio is defined as

$$r_{ab} = N_a / N_b$$

or

$$r_{ba} = N_b / N_a = 1 / r_{ab}$$

If  $r_{ab} > 0$ , then  $a$  and  $b$  have the same direction of rotation, and if  $r_{ab} < 0$ , then opposite directions. "Same direction" means both have positive (or both negative) rotation, where positive has in each case an arbitrarily defined sense. If  $|r_{ab}| > 1$ , then from  $a$  to  $b$  is a reduction, and if  $|r_{ab}| <$

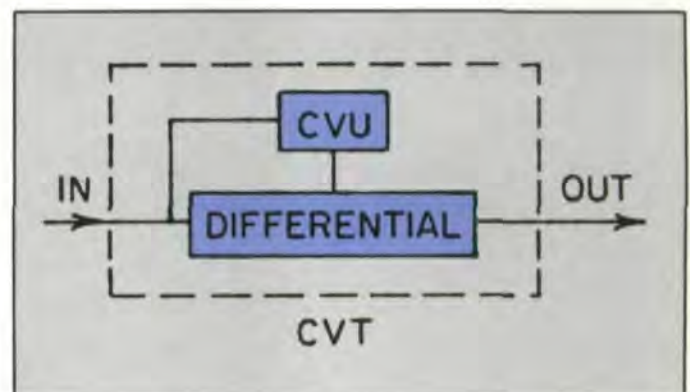

Fig. 1—Schematic diagram of a split-path continuously-variable transmission (CVT)

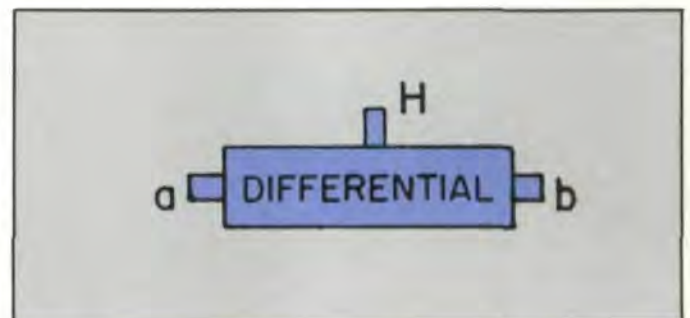

Fig. 2—Schematic diagram of a fundamental gear differential

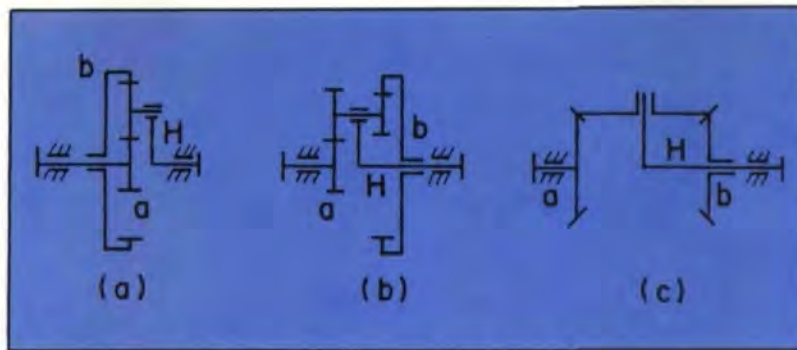

Fig. 3—Three examples of the  $2K - H(-)$  type of differential

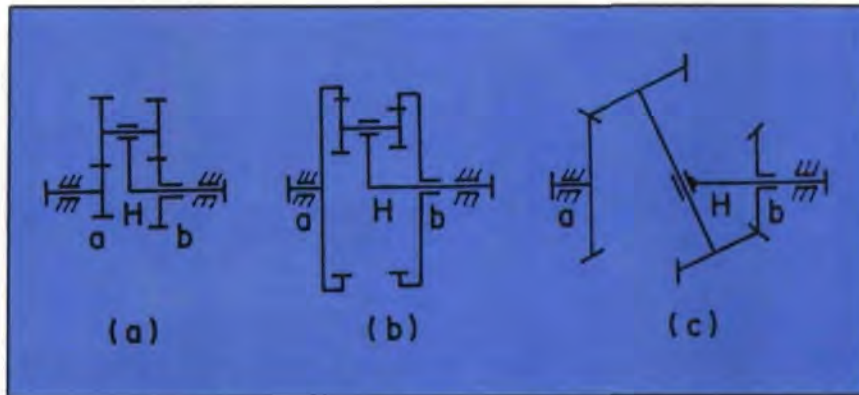

Fig. 4—Three examples of the  $2K - H(+)$  type of differential

1, then from  $a$  to  $b$  is a speed-up or "overdrive". We define a high-speed ratio as occurring when either the absolute value of a reduction speed ratio is very large or the absolute value of an overdrive speed ratio is very small. For example, both  $|r_{ab}| = |N_a/N_b| = 1000$  and  $|r_{ba}| = |N_b/N_a| = 1/1000$  are considered as high speed ratios, and the lowest possible speed ratio is therefore  $|r| = 1$ .

If the speed ratio is relative to a third member, the relative speed ratio should be used, and a superscript should be added to the symbol with two subscripts. For example, the relative speed ratio of  $a$  and  $b$  to  $H$  is defined as,

$$r_{ab}^h = \frac{N_a - N_h}{N_b - N_h} = 1/r_{ba}^h \quad (1a)$$

In the same way,

$$r_{ah}^b = 1/r_{ha}^b = \frac{N_a - N_b}{N_h - N_b} \quad (1b)$$

$$r_{bh}^a = 1/r_{hb}^a = \frac{N_b - N_a}{N_h - N_a} \quad (1c)$$

Thus we can get,

$$r_{ab}^h + r_{ah}^b = \frac{N_a - N_h}{N_b - N_h} + \frac{N_a - N_b}{N_h - N_b} = 1 \quad (2a)$$

$$r_{ba}^h + r_{bh}^a = 1 \quad (2b)$$

$$r_{ha}^b + r_{hb}^a = 1 \quad (2c)$$

Expressions (2) are the fundamental kinematic relations of a differential from which other more complex formulas can be derived.

**Basic Speed Ratio.** In many articles,<sup>(2, 5, 6, 10)</sup> the term "basic ratio of a differential" has been used, but for the purpose of this article, we will define the term more specifically

than is usually done. The basic ratio of a differential should express the specific features of the differential gearing and be convenient for use.

There is only one speed ratio that can not only be related to the size, but also provide the basic characteristics of a differential gearing. It is to be named the *basic speed ratio*  $R_o$ ,

$$R_o = r_{ab}^h$$

(Note, however, that the reciprocal  $r_{ba}^h$  could be used as alternative if so desired.)

The relative speed ratio of  $a$  and  $b$  to  $H$  is based on considering  $H$  as relatively fixed. It, therefore, can be determined in the same manner as that of a conventional gear train, and the relationships of teeth or diameters can be used.

The basic speed ratio can be calculated as

$$R_o = r_{ab}^h = (-1)^p \frac{Z_b \cdot Z_b' \cdot \dots}{Z_a \cdot Z_a' \cdot \dots} \quad (3)$$

where:

$Z_a, Z_a', \dots$  = numbers of teeth of the driving gears from  $a$  to  $b$ ,

$Z_b, Z_b', \dots$  = numbers of teeth of the driven gears from  $a$  to  $b$ .

$p$  = number of pairs of external gearing from  $a$  to  $b$ .

**Basic Types of Epicyclic Gearing.** A central gear  $K$  is defined as one whose axis continuously coincides with the common central axis of the differential.

There are two main types of epicyclic differential:  $2K - H(-)$  as shown in Fig. 3, and  $2K - H(+)$  as shown in Fig. 4.  $2K$  means two central gears, and the single  $H$  means one carrier with planet gears. The '+' denotes  $R_o > 0$ , and '-'

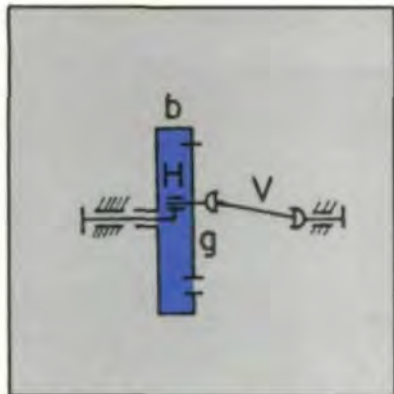

Fig. 5 - The KHV type of differential

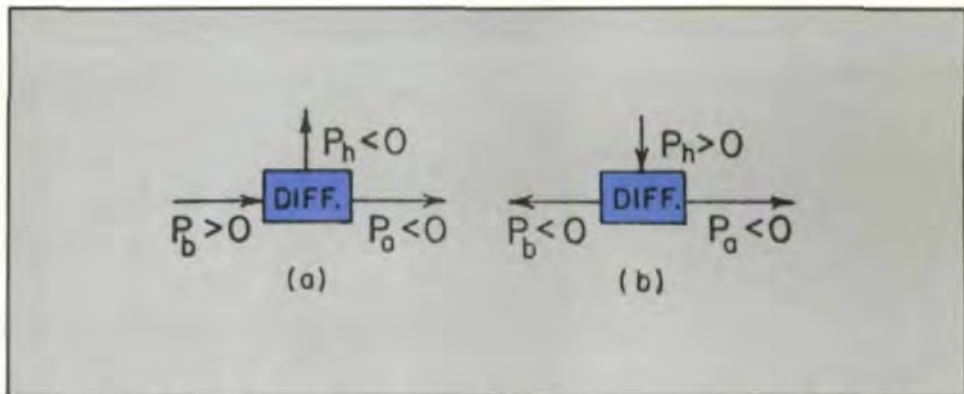

Fig. 6 - Changes in power flow directions that may occur when speed ratios are varied (with independent connections for the three differential elements)

means  $R_o < 0$ . As shown in Fig. 5, a relatively new type of differential is the KHV, consisting of only one central gear, one carrier, and an equal angular velocity mechanism  $V$ , where  $V$  has the same angular velocity as the planet gear  $g$ . It is compact in structure, light in weight, and with optimum design techniques, can often provide a higher efficiency.<sup>(12)</sup> It is, therefore, a very promising type of gearing for some applications. Since there is only one pair of internal gears, the basic ratio  $R_o$  is positive. Some characteristics of the KHV type are similar to those of a  $2K - H(+)$  type. Since the three basic members of a KHV are  $b$ ,  $H$ , and  $g$  (or  $V$ ), all the previous and following equations are valid for it if  $g$  is substituted for  $a$ .

**Efficiency.** Power equals the product of torque and angular velocity, or the product of force and linear velocity.

We define input power  $P_{in}$  as positive, and both the output power  $P_{out}$  and the frictional power  $P_f$  as negative.

Conventionally, efficiency is a positive value, therefore, sometimes a minus sign or absolute value; symbol must be used in the efficiency formulas, such as:

$$\eta = \frac{-P_{out}}{P_{in}} = \frac{P_{in} - |P_f|}{P_{in}} = 1 - \frac{|P_f|}{P_{in}} \quad (4a)$$

and

$$\eta = \frac{P_{out}}{P_{out} + P_f} = \frac{1}{1 + P_f/P_{out}} \quad (4b)$$

#### Power Lost in Friction

If power's lost in friction, simply called frictional power, can be evaluated, it is easy to calculate the efficiency. The principle adopted here is the concept of relative motion, the same method as used for dealing with the kinematic relationships.

Frictional power is a function of torque and relative angular velocity. Let us observe two systems, a differential and a differential with its carrier  $H$  assumed relatively fixed. The angular velocities of the latter system are  $N_a - N_h$ ,  $N_b - N_h$ ,  $N_g - N_h$ ,  $N_h - N_h$ , . . . But the relative angular velocity of any two members, for example of  $a$  and  $g$  ( $N_a - N_h$ ) - ( $N_g - N_h$ ) =  $N_a - N_g$ , is the same as that in the former system, so it is apparent that the two systems provide the same relative angular velocities between each pair of meshed

gears. Because torque is independent of motion, the torque of each element is not affected by whether or not  $H$  is relatively fixed. Consequently, a useful conclusion can be drawn: the frictional power  $P_f$  of a differential can be calculated in all cases by assuming the carrier  $H$  to be relatively fixed.

It is convenient to use the concept of latent power. With  $H$  relatively fixed, we define

$$P_a^h = T_a(N_a - N_h) \quad (5)$$

and

$$P_b^h = T_b(N_b - N_h) \quad (6)$$

There exist two possibilities. The first is that  $a$  is the driving member (input) and  $b$  is the driven member (output) when  $H$  is relatively fixed, i.e.,  $P_a^h > 0$  and  $P_b^h < 0$ ; where  $P_a^h$  and



## PEREZ MACHINE TOOL CO.

11 Ginger Court, East Amherst,  
New York 14051 • (716) 688-6982

Exclusive U.S.A. distributor for the Okamoto  
SHG-360, 400, 600 Gear Grinders



Designed to meet the requirements for precision economical grinding of spur and helical gears, . . .

For aircraft, automotive and machinery applications.

Visit us at Booth #6279, 1986 IMTS

$P_b^h$  symbolize the powers of  $a$  and  $b$  when  $H$  is assumed to be relatively fixed. Strictly speaking, they are not real powers, but since they have the same dimensions as power it is convenient to refer to them as latent powers. Applying equation (4) to the case of  $H$  relatively fixed.

$$\eta_{ab}^h = 1 - \frac{|P_f|}{P_a^h} \quad (7)$$

or

$$\eta_{ab}^h = \frac{1}{1 + P_f/P_a^h} \quad (8)$$

The choice between equations (7) and (8) depends on whether  $P_a^h$  or  $P_b^h$  is available. Then,

$$|P_f| = (1 - \eta_{ab}^h) P_a^h = (1 - \eta_{ab}^h) T_a (N_a - N_h) \quad (9)$$

or

$$|P_f| = (1 - \eta_{ab}^h) P_b^h / \eta_{ab}^h = (1 - \eta_{ab}^h) T_b (N_b - N_h) / \eta_{ab}^h \quad (10)$$

where the superscript  $h$  means that  $H$  is relatively fixed, and the subscript  $ab$  denotes the power flow is from  $a$  to  $b$ .

The relationship between torques can be obtained as follows:

$$\eta_{ab}^h = \frac{-P_b^h}{P_a^h} = \frac{-T_b (N_b - N_h)}{T_a (N_a - N_h)} \quad (11)$$

so

$$\frac{T_b}{T_a} = \frac{-\eta_{ab}^h (N_a - N_h)}{N_b - N_h} \quad (12)$$

The second possibility is that  $b$  is input and  $a$  is output when  $H$  is assumed to be relatively fixed, i.e.,  $P_b^h > 0$  and  $P_a^h < 0$ . In this case,

$$\eta_{ba}^h = 1 - |P_f|/P_b^h \quad (13)$$

or

$$\eta_{ba}^h = \frac{1}{1 + P_f/P_b^h} \quad (14)$$

Then

$$|P_f| = (1 - \eta_{ba}^h) P_b^h = (1 - \eta_{ba}^h) T_b (N_b - N_h) \quad (15)$$

or

$$|P_f| = (1 - \eta_{ba}^h) P_a^h / \eta_{ba}^h = (1 - \eta_{ba}^h) T_a (N_a - N_h) / \eta_{ba}^h \quad (16)$$

For the torque relationship,

$$\eta_{ba}^h = \frac{-P_a^h}{P_b^h} = \frac{-T_a (N_a - N_h)}{T_b (N_b - N_h)} \quad (17)$$

or

$$\frac{T_a}{T_b} = -\eta_{ba}^h \frac{(N_b - N_h)}{(N_a - N_h)} \quad (18)$$

In the same way, expressions of  $\eta_{ab}^b$ ,  $\eta_{ba}^b$ ,  $\eta_{ba}^a$ , and  $\eta_{ab}^a$  could be derived, but only  $\eta_{ab}^h$  or  $\eta_{ba}^h$  can be determined in a direct manner. As shown in the foregoing, one of these two must be used to obtain a solution. This is the reason that we define either  $r_{ab}^h$  or  $r_{ba}^h$  as the basic speed ratio  $R_o$ .

When the carrier  $H$  is relatively fixed, certain features of a differential are similar to those of conventional gearing. Thus, formulas from<sup>(7, 8)</sup> or relevant handbook data available for conventional gearing can be used to calculate  $\eta_{ab}^h$  or  $\eta_{ba}^h$ .

The only remaining question is: when  $H$  is assumed relatively fixed, which one of the two efficiencies should be used, i.e., is  $a$  or  $b$  the input?

Let

$$S_a = P_a^h / P_a = T_a (N_a - N_h) / T_a N_a = 1 - N_h / N_a \quad (19)$$

$$S_b = P_b^h / P_b = T_b (N_b - N_h) / T_b N_b = 1 - N_h / N_b \quad (20)$$

where  $S$  is the ratio of the power assuming the carrier  $H$  relatively fixed to the actual power.

Usually the speed ratios  $N_h/N_a$  and  $N_h/N_b$  are known. If the sign of either  $P_a$  or  $P_b$  is known, then by means of equations (19) or (20) the sign of  $P_a^h$  or  $P_b^h$  can be determined. When  $P_a^h > 0$  or  $P_b^h < 0$ , then  $\eta_{ab}^h$  and equations (7-12) should be used. When  $P_b^h > 0$  or  $P_a^h < 0$ ,  $\eta_{ba}^h$  and equations (13-18) should be used. Thus  $P_f$  will be obtained.

### Efficiency of the Differential

After  $P_f$  is available and if  $P_{in}$  or  $P_{out}$  is known, then the

### Nomenclature

- $K$  = ratio of CVU output power to input power of total system
- $K_o$  = ratio of CVU output power to input power of total system with friction assumed zero
- $N$  = rotational speed
- $P$  = power
- $P_a^h$  = latent power of member  $a$
- $P_f$  = frictional power loss in differential
- $P_{fv}$  = frictional power loss in CVU
- $P_{in}$  = input power
- $P_{out}$  = output power
- $r$  = angular speed ratio
- $r_{ab}$  = angular speed ratio,  $N_a/N_b$
- $r_{ab}^h$  = relative speed ratio  $(N_a - N_h)/(N_b - N_h)$
- $R$  = relative speed ratio of members 3 and 1 to member 2,  $(N_3 - N_2)/(N_1 - N_2)$

- $R_o$  = basic speed ratio of a differential,  $r_{ab}^h$  or  $r_{ba}^h$
- $S$  = ratio of power assuming  $H$  relatively fixed to actual power
- $T$  = torque
- $V$  = speed ratio of CVU
- $Z$  = number of teeth on a gear
- $\eta$  = efficiency
- $\eta_{ab}^h$  = efficiency from  $a$  to  $b$ , assuming  $H$  relatively fixed
- $\eta_d$  = efficiency of differential
- $\eta_{oa}$  = overall efficiency
- $\eta_v$  = efficiency of CVU

### Subscripts and Superscripts

- $a$  = member  $a$  of a differential
- $b$  = member  $b$  of a differential
- $g$  = planet gear  $g$  of a differential
- $h$  = carrier  $H$  of a differential

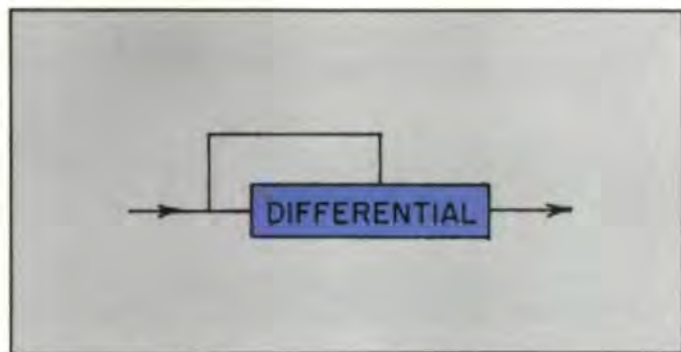

Fig. 7—Power input coupling to a differential

efficiency of the differential can be calculated by means of equation (4). However, we should first determine which of the three members ( $a$ ,  $b$ , and  $H$ ) is or are the input and output.

The torque equilibrium requirement is valid whether friction is omitted or is taken into account (since the basic differential has no torque reaction to ground) is:

$$T_a + T_b + T_h = 0 \quad (21)$$

Using equation (21) in combination with equations (12) or (18) allows two equations related to torques to be obtained, so the relationship between any two torques can be determined.

Power is the product of torque and angular velocity,

$$P_a = T_a \cdot N_a, \quad P_b = T_b \cdot N_b, \quad P_h = T_h \cdot N_h \quad (22)$$

Therefore, the relationship between each two powers can also be calculated.

If the sign of one of the three powers is given, for example,  $P_a < 0$  (i.e.,  $a$  is output), the direction of the other two can be obtained through equation (22). If, for example,  $P_b < 0$  and  $P_h > 0$  (i.e.,  $b$  is another output and  $H$  is input) the differential efficiency is obtained from equation (4) as

$$\eta_d = \frac{P_h - |P_f|}{P_h}$$

or

$$\eta_d = \frac{|P_a| + |P_b|}{P_h}$$

However, it is not as simple as the case of planetary gearing, which has only one degree of freedom. For example, if  $b$  is fixed and  $a$  is output, then  $H$  must always be the input

independent of speed ratio, and vice versa.

Differential gearing has two degrees of freedom. Two of the three members can be input and the other output, and vice versa, so there are six different possible combinations. Moreover, these relationships do not always remain the same throughout all the speed ratios needed. For example, if  $r_{ab}^h = -1.7$  and  $P_a < 0$  ( $a$  is output) are given, then when  $N_a/N_b = -0.03$  we find  $P_b/P_a = -59.6$  and  $P_h/P_a = 57.5$ , i.e.,  $b$  is input and  $H$  is output (Fig. 6a). When  $N_a/N_b = 0.05$ ; however, we find  $P_b/P_a = 53.8$  and  $P_h/P_a = -55.9$ , i.e.,  $b$  becomes output and  $H$  turns into input (Fig. 6b). Therefore, when powers are connected separately to the three members (Fig. 6), care must be taken to determine whether the power signs will change during the speed ratio range being used. If they do change, it is difficult to arrange the power connection of the differential. Consequently, it is impossible to get the general formulas available for all speed ratios. For example, in his article "Power Flow and Loss in Differential Mechanisms",<sup>(10)</sup> Macmillan has derived six general efficiency formulas. Although quite useful, they can only be valid for planetary gearing, not for a differential, since they require one of the three members of an epicyclic gearing to be absolutely fixed and not just relatively fixed. Consequently, the gearing operates with only one degree of freedom, and strictly speaking, two of the six formulas with fixed carrier are equivalent to those for conventional gearing.

#### Split-Path Transmissions Efficiency

To generate formulas that are valid for all speed ratios, it is necessary to couple two of the differential members together rather than to connect power to each element separately. It is most common to use the power input coupled type of system (Fig. 7). A useful transmission for automobiles and other mechanical applications is the input-coupled scheme shown in Fig. 8, where the CVU is a continuously variable speed ratio unit, such as a variable V-belt drive, a Perbury traction drive or some similar device.<sup>(1, 3, 6)</sup>

If we do not include the possibility of regenerative braking, member 3 in Fig. 8 is always the output ( $P_3 = P_{out}$ ) and  $P_{in}$  is always the input. Depending on the system parameters and the speeds of the three differential elements, there are three possibilities: (a)  $P_1 > 0$  and  $P_2 > 0$ , (Fig. 8a) (b)  $P_1 < 0$  and  $P_2 > 0$ , producing what is known as positive power recirculation through the CVU (Fig. 8b), and (c)  $P_1 > 0$  and  $P_2 < 0$ , producing negative power recirculation (Figure 8c).

In all three cases considered, the condition that power is

Fig. 8—An input-coupled split-path CVT showing the three power flow possibilities

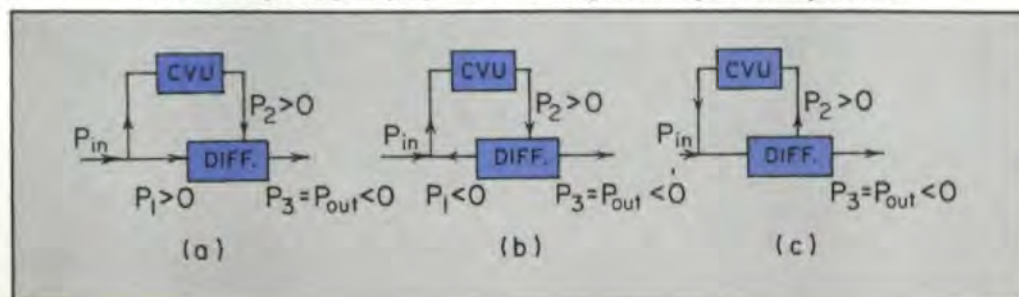

**Table 1**

Six Basic Types of Differential Connection and Nine Combinations

Six Types of Differential Connection	2 Members Which Interchange Positions		
	b, H	a, H	a, b
1.	1	1	1
2.	2	2	2
3.	3	3	3
4.	4	4	4
5.	5	5	5
6.	6	6	6
Nine Combinations	I II III	IV V VI	VII VIII IX

input at "P<sub>in</sub>" and output as "P<sub>out</sub>" remains unchanged, so that the basic scheme of the transmission is the same. The overall speed ratio of the transmission is r, defined as r = N<sub>out</sub>/N<sub>in</sub> = N<sub>3</sub>/N<sub>1</sub>. The speed ratio of the CVU is V = N<sub>2</sub>/N<sub>1</sub>. Let R be the relative speed ratio of 3 and 1 and 2,

$$R = \frac{N_3 - N_2}{N_1 - N_2} = \frac{r - V}{1 - V}$$

then

$$V = (r - R) / (1 - R) \tag{23}$$

or

$$r = R + (1 - R)V \tag{24}$$

If the efficiency of the CVU is η<sub>v</sub> and the power passing through the CVU at the differential side is P<sub>v</sub> = P<sub>2</sub>, then when P<sub>2</sub> < 0, the loss in the CVU is

$$|P_{fv}| = |P_v|(1 - \eta_v) \tag{25a}$$

and when P<sub>2</sub> > 0, it becomes

$$|P_{fv}| = |P_v|(1 - \eta_v)/\eta_v \tag{25b}$$

If the power loss through the differential is P<sub>f</sub>, then the total loss is

$$P_{loss} = P_f + P_{fv} \tag{26a}$$

or

$$P_{loss}/P_{out} = P_f/P_{out} + P_{fv}/P_{out} \tag{26b}$$

The input power of the system is

$$P_{in} = -(P_{out} + P_{loss}) \tag{27a}$$

or

$$P_{in}/P_{out} = -(1 + P_{loss}/P_{out}) \tag{27b}$$

The overall efficiency of the system, which is more important than that of either the differential or the CVU alone will be

$$\eta_{oa} = -P_{out}/P_{in} \tag{28}$$

K is defined as the ratio of the input power of the CVU to the input power of the system. A positive P<sub>v</sub> means that power passes from the CVU to the differential, and vice versa, so that

$$\text{when } P_v < 0 \quad K = P_v/P_{in} \tag{29a}$$

$$\text{when } P_v > 0 \quad K = P_v/\eta_v/P_{in} \tag{29b}$$

**Example**

To help clarify the foregoing, the following example is given: the differential is chosen to be a 2K - H(-) type as shown in Fig. 3a with Z<sub>b</sub> = 153, Z<sub>a</sub> = 90, so that r<sub>ab</sub><sup>h</sup> = -Z<sub>b</sub>/Z<sub>a</sub> = -153/90 = -1.7,

1. The conditions given are: a is the output and H is the CVU; i.e., a at 3, H at 2, and b at 1, R<sub>o</sub> = r<sub>ab</sub><sup>h</sup> = -1.7, and r = N<sub>3</sub>/N<sub>1</sub> = N<sub>a</sub>/N<sub>b</sub> = -0.13.

2. V = N<sub>2</sub>/N<sub>1</sub> = N<sub>H</sub>/N<sub>b</sub>, and from equation (23), V = (-0.13 + 1.7)/(1 + 1.7) = 0.581, and N<sub>H</sub>/N<sub>a</sub> = V/r = -4.47.

3. S<sub>a</sub> = P<sub>a</sub><sup>h</sup>/P<sub>a</sub> = 1 - N<sub>H</sub>/N<sub>a</sub> = 5.47 > 0. Since a is output, i.e., P<sub>a</sub> = P<sub>out</sub> < 0, then P<sub>a</sub><sup>h</sup> < 0, i.e., a is driven when H is relatively fixed. Therefore, assuming η<sub>ba</sub><sup>h</sup> = 0.95 and using equations (13)-(18), we get T<sub>b</sub>/T<sub>a</sub> = 1.789 and T<sub>H</sub>/T<sub>a</sub> = -2.789.

4. From equations (21) and (22), the power relationships are P<sub>b</sub>/P<sub>a</sub> = -13.77, P<sub>H</sub>/P<sub>a</sub> = 12.48, and P<sub>f</sub>/P<sub>a</sub> = 0.288. Since P<sub>a</sub> < 0, then P<sub>b</sub> > 0 and P<sub>H</sub> < 0. Therefore, in the differential b is the input, a and H are outputs.

5. Now using equation (4a), we get the efficiency of the differential, η<sub>d</sub> = -(P<sub>a</sub> + P<sub>b</sub>)/P<sub>b</sub> = 97.9 percent.

6. If the efficiency of the CVU is assumed to be η<sub>v</sub> = 0.9, then from equation (25) we get |P<sub>fv</sub>|/|P<sub>out</sub>| = |P<sub>H</sub>|(1 - η<sub>v</sub>)/|P<sub>out</sub>| = 12.48(1 - 0.9) = 1.248, and from equation (26b) we obtain P<sub>loss</sub>/P<sub>out</sub> = 0.288 + 1.248 = 1.536.

7. The input power needed (equation (27b)) is P<sub>in</sub>/P<sub>out</sub> = -(1 + 1.536) = -2.536. The overall efficiency of the system can now be calculated as η<sub>oa</sub> = -P<sub>out</sub>/P<sub>in</sub> = -1/(-2.536) = 39.4 percent.

Fig. 9 - Power flow diagram of the example

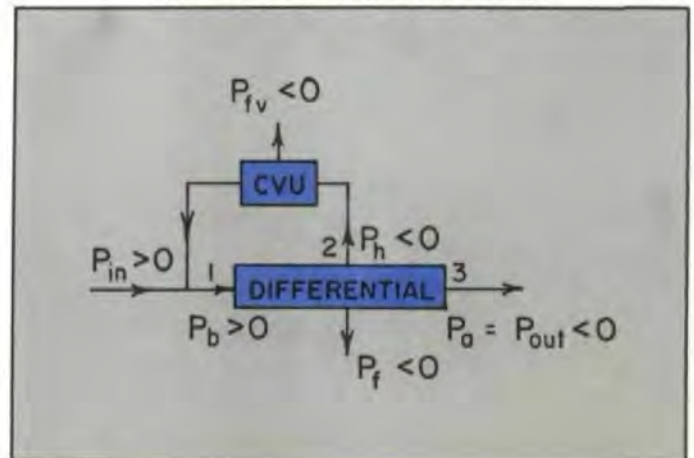

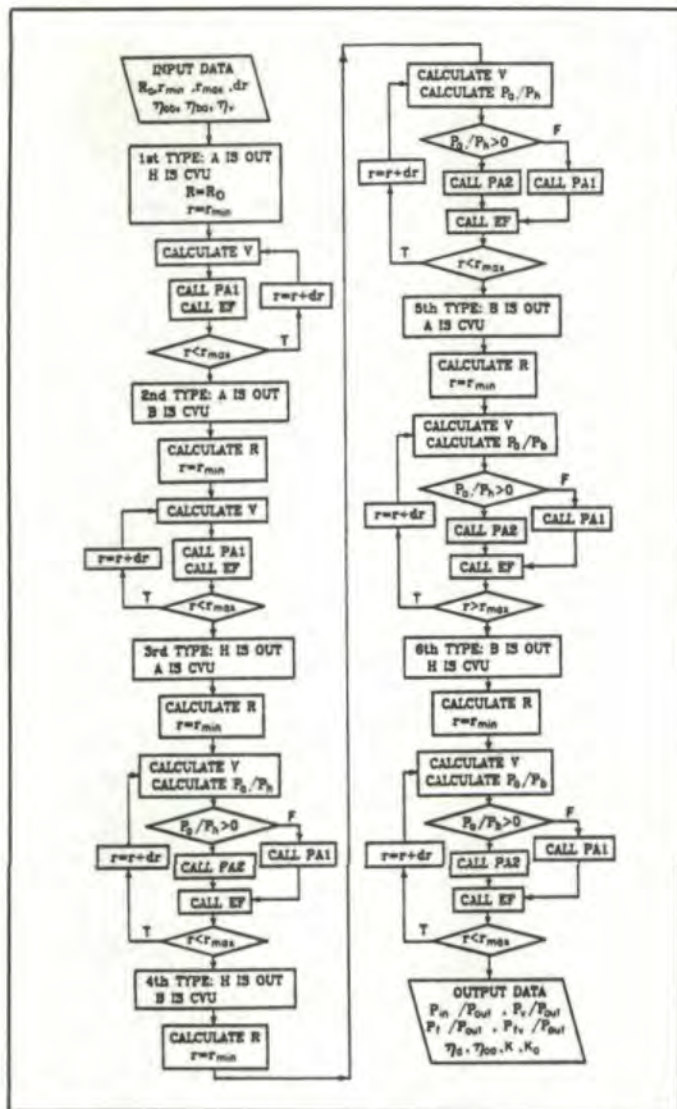

Fig. 10—Computer flow chart calculating program for the input-coupled CVT

8. The portion of the input power passing through the CVU is  $K = P_v/P_{in} = P_h/P_a/(P_{in}/P_{out}) = -4.92$ . The minus sign means negative power recirculation.

9. The power flow directions are shown in Fig. 9.

### Types of Connection

An important and interesting feature should be pointed out: there are six possible types of connection for the three basic members of each differential characterized by its basic speed ratio. Six different designs are available which enlarges the potential usage. For example, for a  $2K-H(-)$  type with  $R_0 = r_{ab}^i = -1.7$ , we have the following six possibilities as listed in Table 1:

1. If  $a$  is output and  $H$  is CVU (i.e.,  $a$  at 3,  $H$  at 2,  $b$  at 1), then  $R = r_{ab}^i = -1.7$  (as in the foregoing example).
2. If  $a$  is output and  $b$  is CVU (i.e.,  $a$  at 3,  $H$  at 1,  $b$  at 2), then  $R = r_{ah}^i = 1 - r_{ab}^i = 2.7$
3. If  $H$  is output and  $a$  is CVU, (i.e.,  $H$  at 3,  $a$  at 2,  $b$  at 1), then  $R = r_{hb}^i = 1/r_{bh}^i = 1/(1 - r_{ba}^i)$ , and  $r_{ba}^i = 1/r_{ab}^i$ ,  $R = 0.630$ .
4. If  $H$  is output and  $b$  is CVU (i.e.,  $H$  at 3,  $a$  at 1,  $b$  at 2), then  $R = r_{ha}^i = 1/r_{ah}^i = 1/(1 - r_{ab}^i) = 0.37$ .

5. If  $b$  is output and  $a$  is CVU (i.e.,  $b$  at 3,  $a$  at 2,  $H$  at 1), then  $R = r_{bh}^i = 1 - r_{ba}^i = 1 - 1/r_{ab}^i = 1.59$ .

6. If  $b$  is output and  $H$  is CVU (i.e.,  $b$  at 3,  $a$  at 1,  $H$  at 2), then  $R = r_{ba}^i = 1/r_{ab}^i = -0.59$ .

Furthermore, if over the range of usage the type of connection can be changed, the design possibilities will be increased still further. Theoretically, 36 different designs are possible, provided that all three basic members can interchange positions. However, practical mechanisms for accomplishing this may be quite complicated. If only two of the three members are to interchange positions, there will be nine combinations as listed in Table 1, and the mechanisms for this will be much simpler<sup>(13)</sup>. For example, if  $b$  and  $H$  can interchange positions over the range of usage, there will be three combinations: *I*, *II*, and *III*. Referring to Table 1, combination *I* means that  $a$  is unchanged as the system output, but  $b$  and  $H$  interchange between the other two connections. The other eight combinations are similarly defined in Table 1. Note further that for any change in the basic speed ratio (i.e., changes in numbers of gear teeth), another six types and nine combinations can be obtained.

From the numerous possibilities, an optimum choice can be made to satisfy particular requirements. The details have been introduced in another article.<sup>(13)</sup>

### Computer-Aided Design

To avoid arduous manual calculations, it is better to design

## AGMA 110 Nomenclature of Gear Tooth Failure Modes

AGMA 110 is the definitive document on gear tooth wear and failure.

Well illustrated, with excellent photographs of distressed gear teeth, it provides descriptions of the failures, their causes, and suggested remedies.

This standard has been widely cited in technical literature and other gear standards. It is indispensable to the serious gear engineer.

Price: \$26

AGMA 110 - Internationally recognized as the authoritative standard on this subject.

Send order with check to:  
Publication Sales  
American Gear Manufacturers Assn.  
1500 King Street, Suite 201  
Alexandria, VA 22314  
(703) 684-0211

Telephone credit card orders accepted



CIRCLE A-13 ON READER REPLY CARD



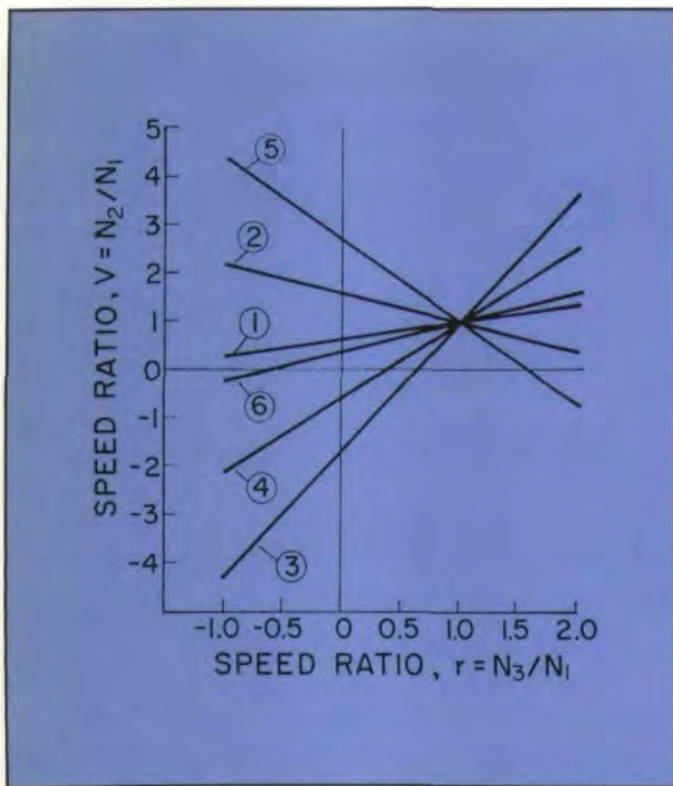

Fig. 11—Required speed ratio relationships of the input-coupled CVT with  $R_o = -1.7$ , for the six ways of using the differential

a general computer program to solve the problem. Two problems have been developed, the first one for calculation and the second for plotting curves. The flow chart of the calculating program is given in Fig. 10. Subroutines PA1 and PA2 are used to calculate torque and power relationships. Subroutine EF is designed to determine efficiency.

The input data are: (1) the basic speed ratio  $R_o$ , which represents the features of the differential gearing, (2) the range of speed ratios of the system, i.e., the maximum and minimum speed ratios, (3) the efficiency of the gearing with  $H$  assumed relatively fixed, and (4) the efficiency of the CVU. Each basic speed ratio (i.e., each specific differential) can provide six different split path CVT designs, and useful curves can be plotted for each.

For example, if the basic speed ratio  $R_o = -1.70$  and it is a  $2K-H(-)$  type, then the relationship between  $V = N_2/N_1$  and  $r = N_3/N_1$  is as given in Fig. 11. If  $\eta_{ab}^h = \eta_{ba}^h = 0.95$  and  $\eta_o = 0.90$ , the overall efficiency characteristics are as given in Fig. 12, and the fraction of power through the CVU as given by Fig. 13. The labeling from 1 to 6 of the different curves is the same as used earlier. With the friction loss assumed to be zero, as is normally the case in other CVT analysis articles, the fraction of power through the CVU is given the symbol  $K_o$ , and the curves of  $K_o$  are shown in Fig. 14. A comparison of Figs. 13 and 14 shows that  $K_o$  is quite different from  $K$ . Fig. 12 also shows that the overall efficiency is often far from 100 percent. It is concluded, therefore, that frictional losses must be included for realistic analysis. From the data and curves obtained, and the CVT characteristics needed, it may be possible to determine a better

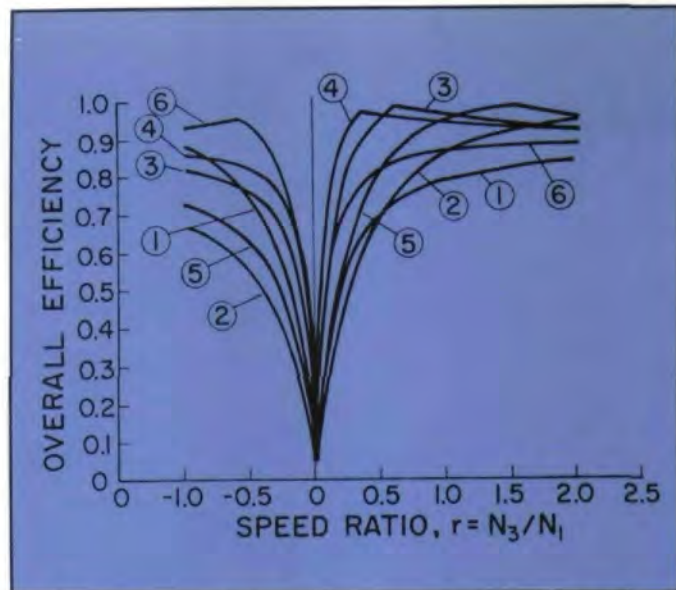

Fig. 12—Efficiency characteristics of the input-coupled CVT for the six ways of using the differential ( $R_o = 1.7$ ,  $\eta_o = 0.90$ ,  $\eta_{ab}^h = \eta_{ba}^h = 0.95$ )

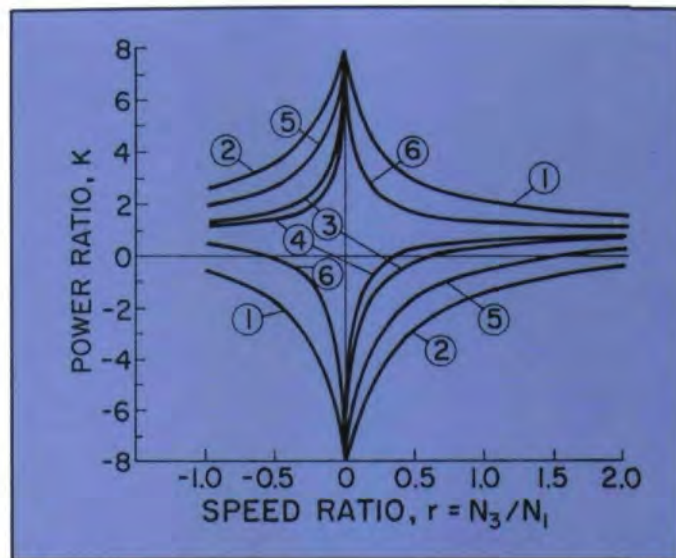

Fig. 13—Fraction of power through the CVU (29) with friction losses taken into account

design. For example, if  $N_3/N_1 = 0.5$  to  $2.0$  is used most of the time, curve 4 may be attractive, because it provides a higher efficiency and a smaller power through the CVU. However, if the available range of  $V = N_2/N_1$  is smaller, it may be better to choose curve 6, because  $V$  varies only from  $0.69$  to  $1.66$ , although the efficiency in this case would be lower.

### Summary

Because of its compact structure, small size, capability of high speed ratios, and the differential action itself, differential gearing has been often employed in modern machinery. However, in many design analyses, an important index, mechanical efficiency, has been ignored. The assumption of

(continued on page 48)

## MECHANICAL EFFICIENCY OF DIFFERENTIAL GEARING . . .

(continued from page 16)

no friction loss certainly does not coincide with reality, and in some cases the analytical results with this assumption will lead to wrong conclusions. The method introduced in this article for analyzing efficiency is simple, explicit, and applicable to all differentials with two degrees of freedom. Although the example given was an input-coupled system, the principles and formulas are equally applicable to output-coupled systems.

It has been pointed out that a "basic speed ratio," given the symbol  $R_0$  in this article, should be defined in a specific manner, so that it will express the significant characteristic features of the differential and be most useful for analysis and calculation.

The classification system of differential gearing used in this article is different from conventional systems such as that given in the *Gear Handbook*.<sup>(14)</sup> This classification is considered advantageous in emphasizing the significant differences of the various design possibilities.

The great number of design possibilities inherent in the use of differential gearing has been pointed out, especially if designs are employed that allow the basic members to interchange positions over the range of operation. Computer-aided design can be of significant help in developing an optimum design from the numerous possibilities. A flow chart and summary of an applicable computer program have been presented.

### References

1. BEACHLEY, N. H., et al., "Continuously-Variable Transmission Designs for Flywheel-Hybrid Automobiles," *Proceedings of the International Symposium on Gearing and Power Transmissions*, Tokyo, 1981, pp. 393-398.

2. WHITE, G., "Properties of Differential Transmissions," *The Engineer*, Technical Contribution Section, July 28, 1967, pp. 105-111.
3. WHITE, G., "A Two-Path Variable-Ratio Transmission with an Extended Range of Ratios," *ASME Journal of Engineering for Industry*, Aug. 1977, pp. 656-661.
4. WHITE, G., "Compounded Two-Path Variable Ratio Transmissions With Coaxial Gear Trains," *Mechanism and Machine Theory*, Vol. 11, 1976, pp. 227-240.
5. MACMILLAN, R. H., and DAVIES, P. B., "Analytical Study of Systems for Bifurcated Power Transmission," *Journal of Mechanical Engineering Science*, Vol. 7, No. 1, 1965, pp. 40-47.
6. STUBBS, P. W. R., "The Development of a Perbury Traction Transmission for Motor Car Applications," ASME paper 80-C2/DET-59, 1980.
7. KUDLYAVTZEY, V. H., *Planetary Gearing* (Russian) Machine-Building Publisher, 1966.
8. YU, DAVID, "Problems Arising in the Calculation of Gearing Efficiency," *Liaoning Machine* (Chinese), No. 2, 1980, pp. 33-42.
9. MACMILLAN, R. H., "Epicyclic Gear Efficiencies," *The Engineer*, Dec. 23, 1949, pp. 727-728.
10. MACMILLAN, R. H., "Power Flow and Loss in Differential Mechanisms," *Journal of Mechanical Engineering Science*, Vol. 3, No. 1, 1961, pp. 37-41.
11. MOROZUMI MUNEHARU, "The Efficiency and the Design of Modified Internal Gearing," *Mechanical Researches* (Japanese), No. 5, 1970, pp. 720-726.
12. YU, DAVID, "The Optimizing Programming Design of the KHV Planetary Gear Driving," *Proceedings of the International Symposium on Gearing and Power Transmissions*, Tokyo, 1981, pp. 295-299.
13. YU, DAVID, and BEACHLEY, N. H., "Alternative Split-Path Traction Drive Transmission Designs for Motor Vehicle Application," *Proceedings, First International Symposium on Design and Synthesis*, Tokyo, July 1984.
14. DUDLEY, D. W., et al., *Gear Handbook*, McGraw-Hill, New York, 1962.

This article was previously presented at the ASME Design Engineering Technical Conference, October 1984. Paper No. 84-Det-102.

Fig. 14—Fraction of power through the CVU for zero friction loss

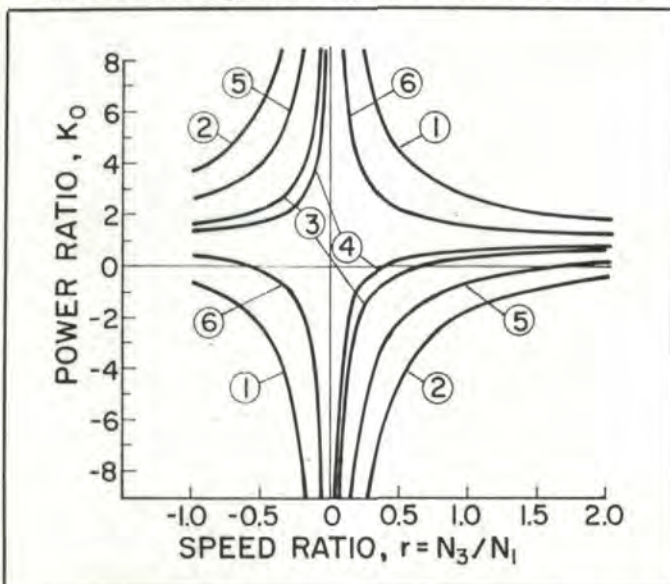

## PROFITS ARE BEING MADE

. . . by advertising in GEAR TECHNOLOGY, The Journal of Gear Manufacturing's classified advertising section. Advertise your specialty:

- Open time on special or unusual machines
- Unique capabilities
- Machine quality
- Help wanted
- Subcontract work

Your ad reaches  
over 5,000 potential customers.  
Call GEAR TECHNOLOGY for details.  
(312) 437-6604