

# IMTS 2018 Booth Previews

## Affolter Technologies North Hall, Booth 237223

Affolter Technologies, in partnership with its U.S. representative, Rotec Tools, will showcase their innovative gear hobbing center AF110 plus at IMTS 2018.

The AF110 plus is the most advanced machine offered by Affolter Technologies. It convinces with its versatility, precision, power, rigidity and ease of use. The AF110 plus has eight axes, a cutter-spindle speed of up to 12,000 rpm capable to make gears with a maximum DP17 and minimum of DP1270. Different automation systems for part loading and unloading are available, such as universal grippers, drum loader or robot loading as well as options such as deburring, dry cutting, centering microscope and oil mist aspiration.

“The loader system AF71 with two grippers ensures 24 hours automatic production,” Vincent Affolter, managing director of Affolter Technologies, said. “While a gear is in the hobbing process, the other gripper already reaches out for the next part to load.”

The AF110 plus can cut spur, helical, frontal, bevel, and crown gears.

Worm Screw Power Skiving, a cutting-edge technology developed by the Affolter engineers, is available as an option. The idea behind it: Unlike in worm hobbing, where the hob turns much faster than the workpiece, the Affolter engineers inverted the process.

“The workpiece turns extremely fast, with two new spindles up to 12,000 rpm, while the cutter turns much slower. Only highly advanced machines can reach such speeds and at the same time provide the necessary stiffness,” Affolter said.

WSPS allows manufacturers to finish a high-precision worm in only 6 seconds — four times faster than the traditional worm hobbing.

“Manufacturers of a high volume of worms will greatly benefit from this new process and improve their productivity significantly,” Affolter said.

The WSPS technology focuses on small worms with a module up to 17 DP.

“The Affolter gear hobbing machines offer customers a

production machine with high precision and efficiency,”

Ivo Straessle, president of Rotec Tools, said. “The simplicity of these machines is remarkable. The user-friendly controls with step-by-step and easy-to-follow functions will simplify the gear-making process. With a relatively small investment, customers can keep know-how and technology in-house.”

### For more information:

Affolter Technologies  
Phone: +41 32 491-70-62  
[www.affelec.ch](http://www.affelec.ch)

Rotec Tools  
Phone: (845) 621-9100  
[rotectools.com](http://rotectools.com)



## American Broach & Machine North Hall, Booth 237020

American Broach & Machine specializes in the design, engineering and manufacturing of turn-key broach machining systems.

### For more information:

American Broach & Machine  
Phone: (734) 961-0300  
[www.americanbroach.com](http://www.americanbroach.com)

## Bourn & Koch

### North Hall, Booth 236854

The global manufacturing community is invited to receive a behind-the-scenes look into how precision machine tools are being built, right here in America, during the Bourn & Koch “Made in America” open house on Wednesday, Sept. 12 and Friday, Sept. 14, 2018.

Tours will be held in Rockford at 10 am and 2 pm both days of the open house. Included in the tours will be a display of select original prints from Blanchard, Fellows, Springfield, DeVlieg, Bullard, Barber Coleman and many other brands which Bourn & Koch, as an OEM for 35 American machine tool brands, is curating.

Full factory tours during the event include the 130,000 square foot shop floor where Bourn & Koch remanufactures classic American machine tools to OEM specifications and also builds brand new Springfield vertical grinders, Blanchard rotary grinders, Bourn & Koch gear hobbors, Fellows shapers and DeVlieg milling machines with the latest technology and designs. A highlight of the tour will be demonstrations of a newly redesigned and reengineered Blanchard 22AD-42 rotary surface grinder.

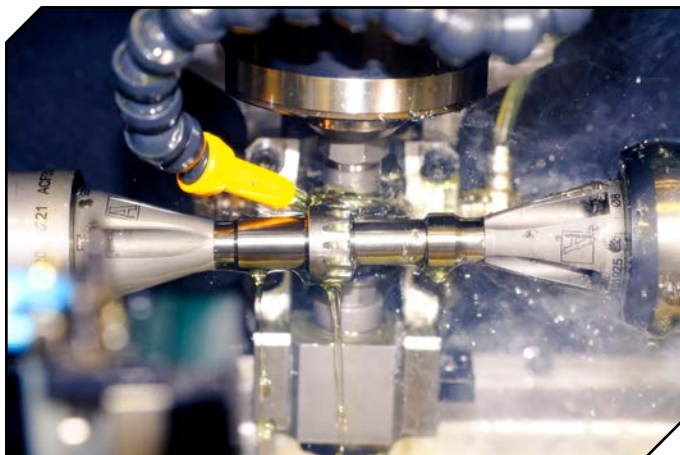

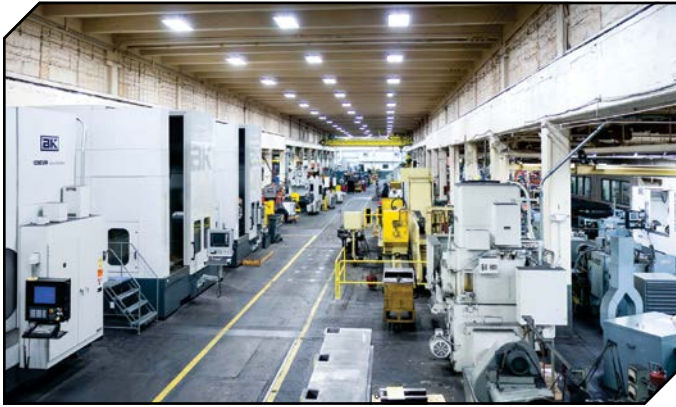

Resident historian, engineer, and Bourn & Koch co-founder, Loyd Koch, will be greeting visitors during the two-day Rockford event. Light refreshments and beverages will be served. RSVP to Tyler Free at Bourn & Koch: [tfree@bourn-koch.com](mailto:tfree@bourn-koch.com).

Bourn & Koch is located in Rockford, Illinois' industrial zone, which is approximately 90 miles from McCormick Place. For those who cannot attend the open house during IMTS, other tour dates are available by appointment request.

Bourn & Koch will simultaneously be exhibiting at IMTS 2018. The company will be showcasing their full line of machine tool solutions including the Springfield VBG vertical grinder, a fully automated Fellows 10-4 gear shaper, Bourn & Koch 100H-T turning and hobbing center and Blanchard 8AD-12 surface grinder. The Springfield VBG offers precision grinding down to 0.0001" as well as integrated vertical turning for single-step production and in-process inspection.

The remanufactured Fellows 10-4 integrates patented electronic crowning and taper technology, BKI-S-HMI and Easy Automate enclosure for standard 3-axis (or optional 6-axis) CNC gear shaping with Fanuc Oi control. The Fellows 10-4 is an affordable way for job shops to introduce high-quality gear manufacturing to their operations. New to the machine is electronic helical guide capability. The machine will be demonstrated with a Halter robot for auto-loading.

The Bourn & Koch 100H-T gear hobber with seven-station turning turret is capable of turning, boring and hobbing up to AGMA Class-13 gears in one setup to save floor space, reduce overall cycle times and increase workpiece accuracy. Shipped with patent-pending adjustable hob arbor spacers and BKI-H-HMI, the machine allows easy setup, programming and manufacturing by novice operators.

The Blanchard 8AD-12 surface grinder is an iconic machine tool, producing the characteristic "Blanchard Grind" synonymous with quality ground parts. Like the Blanchard 22AD-42 being demonstrated at the "Made in America" Rockford open house, the smaller Blanchard 8AD-12 in the Bourn & Koch booth at IMTS has been reimagined and reengineered to meet today's manufacturing challenges.

**For more information:**  
Bourn & Koch Inc.  
Phone: (815) 965-4013  
[www.bourn-koch.com](http://www.bourn-koch.com)

**WFL**   
MILLTURN TECHNOLOGIES

+ The leading machine  
concept for the  
manufacturing of  
complex and precise  
workpieces



IMTS2018

Visit us on our  
booth S-8666



**CLAMP ONCE  
MACHINE COMPLETE**



**US** WFL Millturn Technologies, Inc. | Wixom, MI 48393  
48152 West Road | Autania Tec Center | USA  
Tel +1 - 248 347 93 90 | Fax +1 - 248 347 93 92  
office@wfl-usa.com | www.wfl-usa.com

**AT** WFL Millturn Technologies GmbH & Co. KG | 4030 Linz  
Austria | Währingerstraße 36 | Tel +43-(0)732 - 69 13-0  
Fax +43-(0)732 - 69 13 - 81 72 | office@wfl.at | www.wfl.at



## The Broach Masters/Universal Gear Co.

North Hall, Booth 237106

Manufacturers of broaches, shaper cutters, master gears and gages.

### For more information:

The Broach Masters/Universal Gear Co.  
Phone: (530) 885-1939  
[www.broachmasters.com](http://www.broachmasters.com)

## Drake Manufacturing

North Hall, Booth 236927

At IMTS 2018, Drake Manufacturing will introduce its newest machine tool, the GS:DS dual spindle grinder, further expanding Drake's premium line of thread grinders and milling machines. The dual spindle machine, complete with automation, will be demonstrated throughout the week in Drake's booth.

The GS:DS combines the grinding capabilities of two machines into one. Depending on application, the machine can be equipped with two external grind spindles, two internal grind spindles or one of each. This not only eliminates changeover, but also reduces takt time while maintaining tight tolerances. A programmable B-axis allows for the

wheel to grind both straight and taper sections in one set-up providing excellent concentricity.

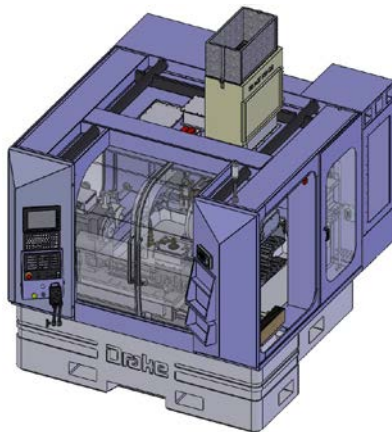

There will be technical presentations offered throughout the show on thread grinding and latest Drake Technologies. Innovation has become a primary focus for Drake as it continues to invest in R&D. While advanced registration is preferred, attendees can also register for these presentations in the Drake booth.

Drake's team of engineers, sales and technical support specialists will be available all week to discuss solutions for your

thread grinding requirements. Don't miss this opportunity to talk threads with the best in the industry! If you prefer to schedule an IMTS appointment, please contact [marketing@drakemfg.com](mailto:marketing@drakemfg.com).

### For more information:

Drake Manufacturing  
Phone: (330) 847-7291  
[www.drakemfg.com](http://www.drakemfg.com)

## DTR Corp.

North Hall, Booth 237017

DTR offers a full line of gear cutting tools, including hobs, carbide hobs, shaper cutters, milling cutters, chamfering and deburring tools, broaches and master gears.

### For more information:

DTR Corporation  
Phone: (847) 375-8892  
[www.dtrtool.com](http://www.dtrtool.com)

## DVS Technology Group

North Hall, Booth 236744

From soft to hard fine machining, from small to large series production, the companies belonging to the DVS Technology Group will be exhibiting trend-setting machine and tool systems for turning, gearing, grinding and gear

# MASTA

The next generation in commercial grade CAE software for design, analysis and optimisation of mechanical drivelines is now available

-  DESIGN
-  ANALYSE
-  OPTIMISE

Find out more at [smartmt.com/cae-software/masta](http://smartmt.com/cae-software/masta)

# SMT



# Swiss Precision Gear Grinding

- cylindrical symmetric and asymmetric gears
- fine or polished ground gears
- twist-free gears or gears with controlled twist
- non-involute gears (cycloid gears)
- tapered gears



Reishauer AG, Switzerland  
[www.reishauer.com](http://www.reishauer.com)

 **IMTS2018**  
Booth N-237030

 **JIMTOF2018**  
The 21th JAPAN INTERNATIONAL MACHINE TOOL FAIR

Reishauer Corporation, Elgin / USA

# REISHAUER

Gear Grinding Technology

honing applications at the IMTS 2018.



Pittler T&S will be presenting the gearing center SkiveLine for the first time in the United States at IMTS. Based on the tried-and-trusted Pittler vertical series, the new platform has been oriented towards Pittler Skiving gear-cutting technology. The SkiveLine provides maximum productivity for the complete machining of components with a diameter of up to 16 inches. Pittler Skiving is a technology used for manufacturing inner and outer gearing in small, medium-sized and large series. The SkiveLine offers enormous potential for meeting the quality and productivity requirements of new drive concepts such as those used in electro-mobility. The hollow wheels of planetary gears are already being series produced completely in two clampings in Europe, with upstream or downstream turning, milling or deburring processes. The machine has been designed both for the gearing of non-hardened (soft) and hardened components. Users can choose between dry machining with compressed air cooling, wet machining or a combination of the two.



The SkiveLine has also been optimized for fully automatic series production: The work chambers of up to two gear centers are automatically supplied with tools via the automation cell, thus minimizing space and investment requirements compared with robot loading. Pittler Skiving also means that Pittler supplies the tools and clamps from a single source.

Praewema Antriebstechnik GmbH will be at the DVS booth and is using

IMTS to present new developments for outer gearing. VarioCrossHoning, a special oscillation method during honing, makes it possible to reduce surface roughness even further and thus further increase the surface quality of components with external gearing. The method can be marveled together with the new, larger honing head with a diameter of 15.75 inch for components with a maximum diameter of 8.7 inch.

Praewema will be presenting a manufacturing solution for the highly efficient production of face crown gearing on claw clutch components to trade visitors at IMTS. Praewema's WPSLV 2-2 has a double spindle and stands out through maximum thermal and dynamic stability, which creates the basis for extremely smooth running of the fly-cutting tool. The rotating milling cutter with only one direction of cutting from the inner to the outer diameter prevents the formation of undesirable burr in the groove of the inner diameter, saving the user complex reworking. The burr at the outer diameter is removed during the milling process using integrated deburring operations which have no effect on the cycle time. In addition, both tooth flanks can be made crowned, which has a positive effect on claw clutch function. Following machining, the components have a code engraved which helps the user trace all the relevant data for component production for years.

DVS Tooling GmbH will be presenting a comprehensive spectrum of tools for Praewema gear honing for both internal and external gearing at IMTS. The dressing tool VSD SF is new in the range. In this case, the letters SF stand for "super-finishing" and refer to the extremely good surface quality. To do justice to these requirements in series production as well, the tools used must be coordinated accordingly. With the VSD SF, DVS Tooling has managed not only to offer tools with extremely tight production tolerances, but also surfaces of  $Rz < 1 \mu\text{m}$  for external gearing.

A further DVS Tooling highlight will be the diamond dressing gear wheels which the company finishes using its own DVS LaserCut method. The diamond wheels from DVS Tooling GmbH thus stand out with great cutting properties, excellent pitch quality and a long

service life.

DVS Tooling has also developed new tool and dressing solutions for the honing process for internal gearing developed by Praewema. Used in conjunction with the Praewema technology, these raise the standard for the surface quality of transmission components with internal gearing to a whole new level.

Buderus Schleiftechnik presents DVS UGrind for the small and medium-sized series production of shaft and chuck parts. The heart of the machine is the flexible multi-function machine head, which is used for grinding, hard-turning and measuring processes in one clamping and without interruption. DVS UGrind's UCee user interface reduces setup time for these processes. Intuitive user guidance allows machining programs to be created quickly and easily even without in-depth programming knowledge being necessary.

Productivity-reducing machining steps such as continual measurement and repeated feeding until the required final dimension has been achieved after clamping are still part of everyday life in small to mid-size workshops. The DVS UGrind makes these steps unnecessary, because the measuring probe integrated in the multi-function head monitors and controls the machining process without the operator having to intervene.

The DVS UGrind can be extended by the ULoad automation cell for fully automated series production. With the aid of a flexible pivoting gripper, the shaft or chuck parts of up to 5 inches in diameter are guided quickly and precisely into the work chamber. Thanks to its own controller, the automation cell works independently and can even be connected to UGrind machines that are already in operation.

Naxos-Diskus Schleifmittelwerke GmbH will also have several innovations on display at the IMTS booth. One highlight is the new Airmento bonding for cold-pressed CBN grinding discs for double-sided face grinding. The newly developed binding stands out thanks to its optimized bonding strength, temperature resistance and enhanced damping behavior during grinding. Correspondingly longer tool service lives, improved conditioning ability as well as higher supply and feed rates for optimized material

## GMS200 Skiving Machining Center for Gear Machine

### Multi-Function Machine to Include Skiving

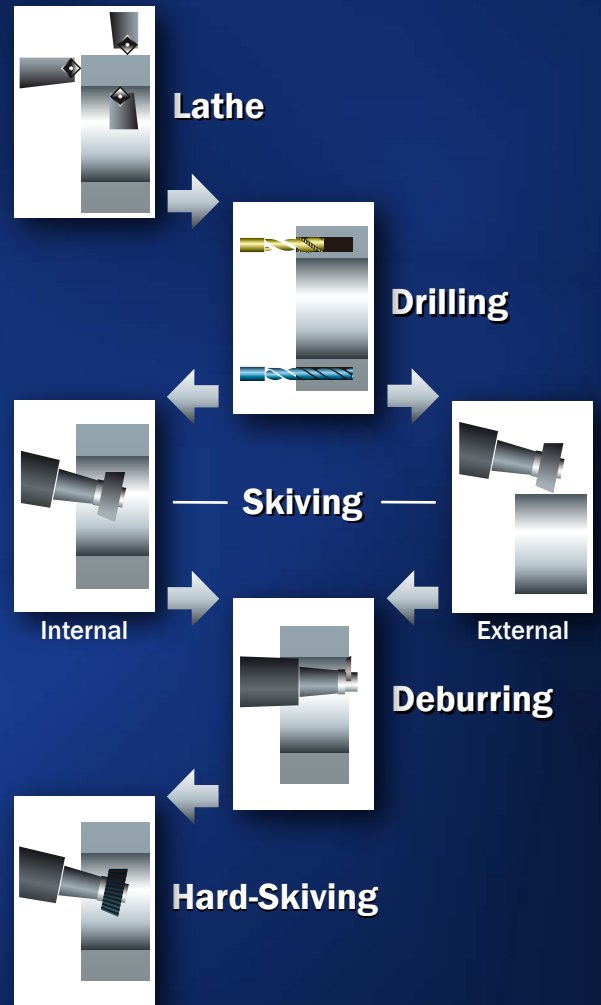

- High Efficiency Gear Skiving & Integrated Process Reduce Machining Time
- Superior Workability & Operability

STOP BY AND SEE US!

 **IMTS2018**  
NORTH HALL #236732

**Nachi America Inc.**

715 Pushville Rd., Greenwood, IN 46143

317-530-1007 • [www.nachiamerica.com](http://www.nachiamerica.com)

removal rates are the result.

#### For more information:

DVS Technology America, Inc.  
Phone: (734) 656-2080  
[www.dvs-technology.com](http://www.dvs-technology.com)

## EMAG

### South Hall, Booth 339436

EMAG will showcase the VL 3 DUO, a compact machine used for the production of gear wheels at IMTS.

When EMAG launched the new TrackMotion automation system in 2015, it quickly became apparent that it not only focused on transporting parts, but on the perfect combination of machine tool, raw parts storage facility and a standard automation solution to create a highly efficient production line.

The consistent adjustment of the automation to the modular machines from its internal production makes it possible to create manufacturing systems using a modular kit.



EMAG is now unveiling another world first, a direct development of the modular machines in combination with the TrackMotion automation system — the VL 3 DUO.

When you first see the machine, you'll immediately notice how compact it is. "We need just 13 m<sup>2</sup> (140 sq ft) to install the complete VL 3 DUO," explained Andreas Frank, product manager for modular standard machines at EMAG. "For a twin-spindle vertical pick-up turning machine, that is a fantastic size. Even if the machine is combined with a raw parts storage facility and the TrackMotion automation system, the dimensions for a complete manufacturing system for chucked parts up to 150 mm (2 in.) is almost laughably small. That makes the VL 3 DUO one of the most compact and efficient systems available from EMAG."

With its parts ranging up to 150 mm (2 in.) in diameter, the VL 3 DUO is ideal for the manufacturing of gearbox

components, for example, machining blanks for gear wheel production. "Gearbox components such as gear wheels must be manufactured in very large quantities. The standard production process is always the same: in OP 10 and OP 20, both sides of the gear wheel blank are machined by a turning process and the surfaces are prepared; the gear cutting process follows in OP 30 and deburring takes place in OP 40," Frank explained. "The VL 3 DUO is, of course, primarily focused on the first process in this machining chain, in other words OP 10 and OP 20, which can be implemented perfectly with our system."

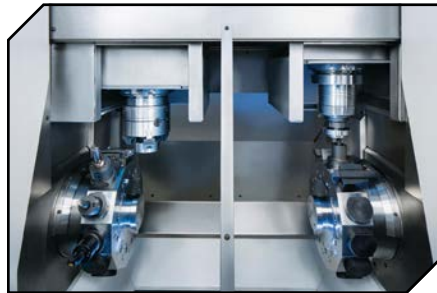

The VL 3 DUO can be fitted with EMAG's TrackMotion automation system as an option. The automation system consists of three central parts, the track (i.e. the rails) on which the TransLift NC gripper runs and the raw parts storage facility. The entire system is very compact and runs directly behind the machining areas of the VL 3 DUO. The TrackMotion always focuses on the individual component. Each transport process only moves a single component which allows for significant benefits for component management. The increased mobility of the TransLift, including the Z-axis, means that stackable pallets can be used on the raw parts storage facility, making it possible for the raw and finished parts to be stacked with minimal space requirements. In addition, the TransLift is also used as a changer between the two machining operations. This means that the TrackMotion automation system provides everything required for compact manufacturing on the VL 3 DUO: an extensive parts storage area that accommodates up to 400 parts and a fast, flexible parts transport system between the various manufacturing stations.

Like every modular machine, the VL 3 DUO has its own parts buffer and a

pick-up spindle in each machining area. The TrackMotion automation system loads the individual part pallets on the parts buffer as they shuttle between the loading position near the machining area and the rear section of the machine. From there, the working spindle takes the raw part, transports it into the relevant machining area and places the part back onto the appropriate pallet after it has been machined. Immediately next to it, the subsequent part is waiting to be picked up by the spindle, so that only a few seconds pass until the next part is being machined.

The machining areas are arranged in a mirror constellation and each has its own working spindle which, with a rating of up to 18.1 kW and torque of up to 142 Nm, has plenty of power for high speed, precision machining.

In addition, each machining area has a tool turret with twelve tool positions which can be fitted with turning tools or driven tools. "The turrets can also be fitted with an additional Y-axis to extend the range of uses of the machine even further," Frank explained.

The VL 3 DUO adds a highly productive, compact manufacturing system for large-scale production to EMAG's modular machine family.



"Its real strength can be seen when it is connected to other machines in the modular machine family," Frank continued. "Let's look at the example of gear wheel production mentioned above."

If we supplement the VL 3 DUO with the VL 4 H, the modular gear hobbing machine from EMAG Koepfer, and a VLC 100 CC or VLC 100 RC, the vertical chamfering and deburring machines, we create a manufacturing system for gear wheels which is completely linked using the TrackMotion automation system, with a very small footprint. The whole thing is made possible by the standard structure of the modular machines, the integrated automation system and the fact that the transfer height between the machines is always identical — it's simply brilliant! In other words, almost as simple as using building blocks."

**For more information:**

EMAG L.L.C.  
Phone: (248) 477-7440  
[www.emag.com](http://www.emag.com)

**Emuge Corp.**

**West Hall, Booth 431536**

At IMTS this year, Emuge Corp. will showcase its comprehensive line of clamping solutions. Emuge's workholding division specializes in providing highly accurate, almost maintenance-free customized solutions for

applications from low volume job shops to high volume automotive production environments. ([www.emuge.com/products/precision-workholding](http://www.emuge.com/products/precision-workholding))



"Our workholding group stays close to our customers to learn about their unique challenges and production environments. Doing so helps us develop the best solutions for their applications," David Jones, precision workholding manager at Emuge Corp., said.

The precision workholding lineup on display will include:

With its expanding-bush design, Emuge's System SG is used in many machining operations such as hobbing, shaping and shaving for gear production, as well as milling and inspection. The

System SG's large surface area contact with the workpiece provides a clamping solution which is very rigid, accurate and repeatable.

The high precision System SP is used not only to clamp workpieces but also to clamp tools. By applying an axial force, the clamping sleeves move in the direction of the force and expand radially. This eliminates the clearance between clamping sleeve and body and between clamping sleeve and workpiece. System SP achieves concentricity of < 0.002 mm (corresponding to < 0.0001 inch).

For workpieces that have a short clamping base or for diameters with a very large tolerance, System SZ is the best choice. By applying an axial force, a slitted collet is radially expanded by a cone. Simultaneously an axial movement occurs, clamping the workpiece.

When the eccentricity between pitch circle and seating bore is very small, diaphragm clamping System SM is ideal. It allows clamping of the gear wheel at the pitch circle for machining the seating bore. The gear wheel is clamped in both axial and radial directions.

# All The Gear Cutting Tools You Will Ever Need Are Right Here

## DTR is one of the world's largest producers.

**DTR. Your best choice for high quality gear cutting tools.**

DTR is a world class supplier of the finest high performance long-life gear manufacturing tools, for small and large gear cutting applications. Established in 1976, we are one of the world's largest producers of cutting tools, shipping to over 20 countries.

- DTR offers a full line of gear cutting tools including:
- Hobs
  - Carbide Hobs
  - Shaper Cutters
  - Milling Cutters
  - Chamfering and Deburring Tools
  - Broaches
  - Master Gears

We can produce virtually any tool you need for auto, aerospace, wind, mining, construction and other industrial gears.

Every tool is precision-made utilizing high speed steel, premium powder metal or carbide and the latest in coatings, to achieve superior cutting and long life. DTR uses top of the line equipment including Reischauer CNC grinders and Klingelberg CNC sharpeners and inspection equipment.

Learn more about our outstanding quality tools at [www.dtrtool.com](http://www.dtrtool.com).  
Call us at 847-375-8892 for your local sales representative or  
Email [alex@dtrtool.com](mailto:alex@dtrtool.com) for a quotation.



**IMTS2018**  
**BOOTH #N-237017**



**PERFECTION MOVES US**  
(formerly Dragon Precision Tools)  
[WWW.DTRTOOL.COM](http://WWW.DTRTOOL.COM)

**DTR has sales territories available. Call for more information.**

**U.S. Office Location (Chicago) Email inquiries to: [alex@dtrtool.com](mailto:alex@dtrtool.com).**  
1865 Hicks Road, Suite A, Rolling Meadows, IL 60008  
**PHONE: 847-375-8892 Fax: 224-220-1311**

Headquarters  
85, Namdong-daero 370beon-gil, Namdong-gu, Incheon, Korea, 21635  
**PHONE: +82.32.814.1540**  
**FAX: +82.32.814.5381**



**For more information:**

Emuge Corp.  
Phone: (508) 595-3600  
[www.emuge.com](http://www.emuge.com)

### **Euro-Tech Corporation** **West Hall, Booth 432453**

Euro-Tech will be presenting the products of a few of the companies they distribute in North America for.



One example is Mytec-Hydraclamp's new Perman-System, which will be introduced at IMTS 2018. In recent years Mytec-Hydraclamp customers were looking for more loading clearance combined with high accuracy and stability due to the introduction of Industry 4.0, the networking of machines and factory automation. To meet that need they developed the hydra-mechanical-based Perman-System.



The mechanical clamping tool is directly actuated with the drawbar of the machine or permanent with springs while the hydra-mechanical clamping tool is actuated directly by the hydraulic system of the machine.

The technical advantages are high loading clearance, a runout accuracy of < 0,005 mm (0,0002"), high gripping force, pull-back function (axial clamping force) and modular design with an interchangeable collet (quick change).

At IMTS 2018, Frenco will also introduce the ZWP 30 for large gears, shafts and worms at Euro-Tech's booth. The ZWP 30 can work with workpieces up to 500 mm in diameter and features a high precise granite base, an ergonomic arrangement of controls, and widely adjustable height with a 30 mm opening path. There's also an optional fixture for worms.

**For more information:**

Euro-Tech Corporation  
Phone: (262) 781-6777  
[www.eurotechcorp.com](http://www.eurotechcorp.com)

### **Felsomat USA** **North Hall, Booth 237030**

Felsomat is a manufacturer of high precision machine tools and automation systems used in high volume automotive parts manufacturing. We specialize in gear manufacturing for automotive transmissions, cam manufacturing and assembly for engines and high performance machine tool loading systems for a wide range of automotive components.

**For more information:**

Felsomat USA  
Phone: (847) 995-1086  
[www.felsomat.com](http://www.felsomat.com)

### **Frenco GmbH** **West Hall, Booth 432453**

See Euro-Tech.

### **German Machine Tools of America**

#### **North Hall, Booth 237054**

German Machine Tools of America, founded in 1991 as the U.S. subsidiary of Profilator GmbH in Wuppertal, Germany and based in Ann Arbor, Michigan, today represents various lines of German machine tools and metal fabricating equipment, including gear cutting and honing, parts washing systems, special machine tools, tooling, laser welding, surface grinding and deburring machines, multi-spindle lathes, multi-station vertical turning machinery and more.

**For more information:**

German Machine Tools of America  
Phone: (734) 973-7800  
[www.gmtamerica.com](http://www.gmtamerica.com)

### **Gleason Corporation** **North Hall, Booth 237000**

At IMTS 2018, Gleason will demonstrate smart innovations in advanced gear manufacturing at their booth, covering a wide array of processes for the complete

production and inspection of all types of bevel and cylindrical gears. Highlights include hobbing with integrated chamfer cutting solutions, hard finishing of gears by Power Skiving, bevel gear grinding with integrated, fast automation and revolutionary multi-sensor metrology incorporating laser scanning for in-process inspection. These new developments are accompanied by the latest flexible workholding solutions and cutting tool technologies, like the new bevel gear cutting system Pentac Mono or new dressing tools for grinding and honing applications.

There will also be live demonstrations of the open software architecture of the new GEMS Gear Engineering and Production System that seamlessly integrates with the latest version of KISSsoft Gear and Transmission Design Software. Gleason's vision and current solutions for the factory of the future will be on display throughout all exhibits including tool-to-machine communication, Gleason Fingerprint for predictive maintenance and the introduction of augmented reality into maintenance and service.

**For more information:**

Gleason Corporation  
Phone: (585) 473-1000  
[www.gleason.com](http://www.gleason.com)

### **Kapp-Niles** **North Hall, Booth 237024**

The Kapp-Niles group specializes in the manufacture of gear grinding machines, including both profile grinding and generating grinding. In addition, Kapp-Niles manufactures dressing tools and grinding wheels for their machines. The Kapp-Niles Metrology division offers dedicated gear inspection equipment as well as a range of gages and other measuring tools.

**For more information:**

Kapp-Niles  
Phone: (303) 447 1130  
[www.kapp-niles.com](http://www.kapp-niles.com)

### **Klingelberg** **North Hall, Booth 236817**

With its closed loop system for cylindrical gears, a hybrid solution for optical measurement and a digital identification system for tools, Klingelberg is now engaged in three areas of innovation. The solutions provider will showcase these innovations at IMTS 2018.



Klingelnberg is presenting the system provider's greatest innovations at the largest trade show for manufacturing technology in North America and will showcase what is possible these days in terms of digitalization in production. On that account, the mechanical engineering company is bringing the cylindrical gear generating grinding machine Speed Viper 300 with KOENIG Automation, the P 40 precision measuring center (into which the innovative optical measuring technology, Klingelnberg Optical Metrology, will first come into use) and SmartTooling digital tool management to the stage. Each of these machines and solutions represent the newest in state of the art technology and work together in a cyber-physical production system in which every step in the value chain is described by a digital twin. Therefore, Klingelnberg is setting benchmarks for production in the Industry 4.0 era. In June 2018, the trade magazine MM Maschinenmarkt just awarded the company the Best of Industry Award in the Industry 4.0 category.

A winner of the iF-Design Award, the Höfler cylindrical gear generating grinding machine Speed Viper was developed by Klingelnberg with a very particular focus on high-production generation grinding in the large-scale series. To do this, the development team has further tested the boundaries of that which is technologically possible in productivity. With a cutting speed range of 100 meters/second, the Speed Viper 300 — which will be exhibited at the trade show — achieves extremely high productivity.



In doing so, the Speed Viper platform is optimally designed for the Industry 4.0 manufacturing environment. This most recent development makes it possible to connect cylindrical gear machines directly to the measuring devices. This technology is already being used successfully in bevel gear manufacturing. By transferring the closed loop concept established by Klingelnberg to the world of cylindrical gears, the mechanical engineering company has made another systematic step toward digitalization in gear manufacturing. Due to a wide variety of associated applications and software, Klingelnberg is implementing central production control using its cyber-physical production system, which will standardize rating results on different machines and even in different plants.

Klingelnberg will have a measuring machine designed for these types of closed loop processes live at IMTS. The P 40 represents future-proof quality management of gears and it showcases Klingelnberg's new, ergonomically optimized design. The fully automatic CNC-controlled precision measuring center is conceptualized as a compact unit for the workpiece diameter range up to 400 mm. The machine and software concept is optimized for the measurement of complex drive components using a technology that replaces up to six conventional measuring devices: gear measurement, general coordinate measurement, form and position measurement, roughness measurement, contour measurement and optical measurement. Maximum measuring and reproduction accuracies are guaranteed — the P series represents a widely used standard in the industry. The P 40 that Klingelnberg is presenting at the IMTS is equipped with a unique feature.



Klingelnberg has equipped a P 40 with the new optical measuring technology for the first time specially for the trade show. Klingelnberg Optical Metrology is a smart combination of tactile and optical measurement. It combines the benefit of quick measured value logging using an optical sensor, with the flexibility and the extremely high accuracy of the tactile 3D Nanoscan sensor system. In this way, the hybrid system distinguishes itself through its extremely rapid changeover from the tactile to the optical system and is designed so that the optical sensors can be adapted in a number of ways. In addition to this combination, optical measured value logging alone is also possible, of course. The measuring result then takes the form of a high-resolution 3D point cloud, which can be further processed and evaluated as a CAD file. The optical measurement is a new, extremely efficient option for the precision measuring centers of the P 26, P 40, P 65, P 100 and P 100L series. At the IMTS, visitors can see the advantages of the P 40 demonstrated live.

With SmartTooling, Klingelnberg is introducing a digital identification system for tools and clamping tools and is consistently further incorporating the bevel gear cutting machine into the Industry 4.0 subject area. With a look toward an extensive cyber-physical production system, it is a case of designing processes which are currently still carried out manually to be more efficient using software support and of establishing the basis for automation. SmartTooling facilitates traceability, and

with it, a 360 degrees view of the production equipment. The additional data that is currently available also provides a good basis for the identification of optimization potential in process improvement. The goal is to support customers both in reducing costs and in increasing production quality.

**For more information:**

Klingelberg America Inc.  
Phone: (734) 470-6278  
[www.klingelberg.com](http://www.klingelberg.com)

**Koepfer America/Helios Gear Products**

**North Hall, Booth 236906**

Visit the Koepfer America / Helios Gear Products booth 236906 at IMTS to see and learn about the latest in gear manufacturing solutions with integrated automation. Located at the Gear Pavilion in the North Building, this exhibit will feature Koepfer CNC hobbing and automation technology, CNC hob and cutter sharpening technology, and the latest Monnier + Zahner (“MZ”) CNC hobbing and automation technology. You can also learn about world-leading automated gear deburring and chamfering solutions, worm milling machines, cutting tools, and hard finishing solutions.

**For more information:**

Koepfer America  
Phone: (847) 931-4121  
[koepferamerica.com](http://koepferamerica.com)

**Leistritz**

**North Hall, Booth 237052**

Leistritz has developed internal whirling, a process to cut long internal threads without tilting the tool at helix angle. The method utilizes the bore to support the carbide or CBN cutting tool for extremely accurate profiles and overall geometries. This special purpose machine, model LWN-120-IW has high frequency oscillation to cut threads with high helix angles and/or multiple starts. .

**For more information:**

Leistritz  
Phone: (201) 934-8262  
[www.leistritzcorp.com](http://www.leistritzcorp.com)

**Liebherr**

**North Hall, Booth 236914**

Liebherr Automation Systems will demonstrate its new PHS Allround pallet handling system, designed to enable a broad range of shops to engage in flexible production in combination with 4- and 5-axis machining centers, at IMTS

2018. The new modular concept, available in three capacities, can handle loads up to three tons, is extremely flexible and can be individually configured and expanded. This corresponds to pallet sizes of 500×500 mm to 1000×1000 mm. Users can introduce flexible production systems with manageable investment and expand them when necessary.



The customer is able to combine pre-configured modules as needed to match production handling needs: the storage locations can be arranged in a circular pattern, with one or more machines, or in a line.

According to Liebherr, this extremely space-efficient system fits in almost every production floor. The user can easily expand a production system with the Allround, spreading investment over different expansion stages. It is no problem to start with one or two machines and increase this number to five, for example, as production changes.

For all Liebherr pallet handling systems (RLS, PHS Pro and PHS Allround), Liebherr offers a new cell control with simple operation as its priority. The new graphically-guided interface concentrates functions on the main computer in a user-friendly manner, and if required also allows full production control. This includes resource planning, cutting tools and NC data management plus also interfaces to the ERP systems.



Liebherr will also demonstrate its

gear skiving process on its LK series machines based on the tried-and-tested components of the corresponding large hobbing machines but equipped with greater rigidity and more powerful spindles. A gear skiving machine requires a table with a direct drive owing to the high workpiece speeds required. This drive works with an automatic control that constantly has the optimal parameters. The complex clamping fixture, which links the workpiece and the machine, is designed by Liebherr.

As skiving is a highly dynamic process, the machine is supplied on a “turn-key” basis with individual clamping fixtures for each workpiece, precise rigidity and contour accuracy.

“This overall view is an important part for the production success,” explains Siegfried Schmidt, team leader in development and design of skiving. “A complex process such as skiving has many specific obstacles, which we overcome with very specific mathematical solutions.”

With its skiving3 program, Liebherr not only provides the LK 300 or 500 skiving machine, but a whole process, including machine, tools and technology for gear production. This integrated approach from Liebherr has already been tried and tested in practice. For many customers, the process of skiving is new, and therefore the operators of the machines need comprehensive training and assistance. On top of that, the tool design is a very complex issue

Skiving3 is especially popular for internal gearing with medium size and quantity as it is much faster than shaping and more economical than broaching. In situations where gear skiving is not possible or appropriate, owing to interfering contours or quantities that are too low, Liebherr still offers technological alternatives with gear shaping and gear hobbing.

The newly developed LHGe@rTec control system also contains the mathematical formulas for pressure angle corrections. This way, quality improvements can be easily achieved via the kinematics of the machine.

The optional tool changer, which can be used to change between roughing and finishing tools, for example, is new. Liebherr offers a ringloader as a standard option for the workpiece changing

device; other automation solutions, such as belts and robots, can also be realized upon request.

**For more information:**

Liebherr Gear Technology and Automation Systems  
 Phone: (734) 429-7225  
[www.liebherr.com](http://www.liebherr.com)

**Luren Precision  
 North Hall, Booth 237058**

Luren offers machine tools for manufacturing gears, including the new LVC-100 CNC Spiral Bevel Gear Cutting machine. In addition, for over 20 years, Luren has been offering a wide variety of custom and standard gear cutting tools.

**For more information:**

Luren Precision  
 Phone: (847) 882-1388  
[www.lurenusa.com](http://www.lurenusa.com)

**Mahr  
 East Hall, Booth 135608**

Mahr Inc. will highlight the new MarSurf contour drive (CD) series of surface finish and contour measurement systems, the MarSurf CM series of Optical 3D surface metrology systems and Micromar series of digital

micrometers at IMTS 2018.

Attendees can visit the Mahr booth and take a photo with the Joe Gibbs Racing No. 18 M&Ms Toyota Camry driven by Kyle Busch. Those that post images to Twitter with #MahrWins will be entered to win official Joe Gibbs Racing memorabilia. Joe Gibbs Racing engineers leverage Mahr precision measurement tools to ensure the highest quality and performance for their NASCAR Cup Series championship drivers.

The MarSurf CD series takes contour measurement to never before seen levels of speed, flexibility and precision, allowing users to improve the manufacturing quality of workpieces with faster throughput, higher accuracy and flexibility for a broader range of workpieces. The MarSurf CD allows for the measurement of the shape of a surface, often referred to as the contour or form, and provides dimensional information such as angles, depths, distances and radius.



The ground-breaking designs of the new MarSurf series significantly increase the speed of all moving axes to reduce the cycle time of the measurement process, allowing more throughput. The drive units of the MarSurf CD series move the contour probe with positioning speeds of up to 200 mm/s, making the systems up to 25 times faster than predecessors. All Z-axis columns on the measuring stands of the MarSurf CD

Class I accuracy  
 Granite column  
 Thermally compensated  
 High capacity table bearing  
 Linear drives  
 Motorized tailstock  
 Universal analysis software  
 Free unlimited software support  
 "Closed loop" corrections to production machines  
 Probe changer  
 Quick change of tooling

Made in USA





**KAPP NILES**  
Metrology

**PGM 165**

**PGM 400**

**KAPP NILES Metrology | Dayton**    [info@kapp-niles.com](mailto:info@kapp-niles.com)    [www.gearinspection.com](http://www.gearinspection.com)    (937) 660-8182

series are fully CNC-capable with fast positioning speeds of 50 mm/s, which is twice as fast as previous systems and five times faster than others on the market. The high dynamic response of the probe system also allows for significantly higher measuring speeds with newly-designed probe arms.

The new MarSurf CM's innovative confocal technology with high-precision 16-bit HDR technology delivers high-resolution 3D surface topography data, enabling new insights into surface structures and processing. MarSurf CM systems provide micron and nanometer resolution surface finish and micro-geometry information including: 2D and 3D surface roughness, bearing area, flatness, depth, volume and much more. The technology allows for the physical acquisition of a true-height signal as opposed to measuring height via pixel contrast, pattern projection, etc. Confocal technology can be used on any material from highly light scattering to highly reflective. Stable construction and a robust optical principle produce reliable results that can be used in laboratory or production environments.



Mahr will also be introducing its expanded range of Micromar 40 series digital micrometers. The Micromar 40 EWRi-L micrometer, with its high-speed measuring spindle positioning, allows for making measurements 10 times faster than a standard micrometer when numerous different dimensions need to be measured on one workpiece. The “non-rotating” sliding spindle also protects sensitive workpiece surfaces against measuring damage, and the integrated wireless system enables the measurement to be very convenient. Versions are also available with MarConnect data processing where the data output format is selected by the cable — either RS-232, USB or Digitmatic.

In addition, a series of new capacities for the Micromar 40 EWRi digital micrometer with integrated wireless data transmission are being unveiled at the show. The Micromar 40 EWRi digital micrometer is now available in eight ranges of 0 through 8" in 1" increments (0 through 200m in 25mm increments), setting new standards. Similarly, a complete line of 40 EWR micrometers is also available in wired versions using Mahr's unique MarConnect interface. These micrometers feature 10 mm digits on a high contrast digital display, an easy to understand tolerance display with warning limits, a reference system that requires the zero position to only be set once and a “hold” function where measured values can be “frozen” on the push button and can be safely read off from a machine.

Attendees will also have the opportunity to trade up to a new wireless digital caliper at the booth. Those who trade in a digital caliper from specific competitors will receive a new MarCal 16 EWRi digital caliper at no cost. Quantities will be limited and available on a “first come, first serve” basis daily.

**For more information:**  
Mahr Inc.  
Phone: (401) 784-3100  
[www.mahr.com](http://www.mahr.com)

**Mitsubishi Heavy Industries America, Inc.**  
**North Hall, Booth 237036**

AT IMTS 2018, Mitsubishi Heavy Industries America, Inc. will be displaying gear cutting and gear grinding technology designed for high productivity. Utilizing Super Dry hobbing, the model GE15A gear hobbing machine can also be equipped with an on-board chamfering station providing multiple processes.

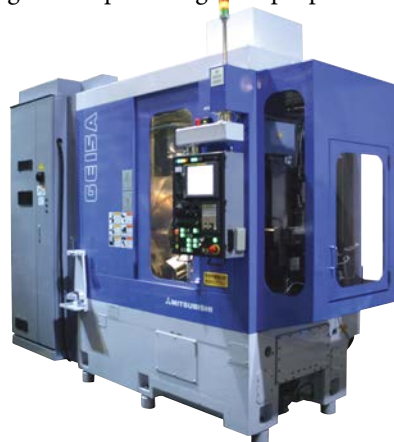

Additionally, MHIA will display the ZE24B generative gear grinder. Designed for mass production, the ZE24B has an automatic parts loader and can perform gear tooth polishing with a single setup using a compound grinding/polishing wheel.

Both the GE15A hobbing machine and the ZE24B gear grinder represent Mitsubishi's legendary reliability in gear manufacturing.

**For more information:**  
Mitsubishi Heavy Industries America, Inc.  
Phone: (248) 669-6136  
[www.mitsubishigearcenter.com](http://www.mitsubishigearcenter.com)

**Nachi America**  
**West Hall, Booth 432024**

Nachi offers machines for gear manufacturing, including the new GMS450 skiving machining center for gears, with integrated skiving, drilling and turning functions. Other machinery offered by Nachi includes broaching, roll-forming, skiving and shaping machines. The cutting tools division offers a wide variety of gear cutting tools, including broaches, hobs, shaper cutters and shaving cutters, as well as resharpening and coating services.

**For more information:**  
Nachi America  
Phone: (317) 530-1001  
[www.nachiamerica.com](http://www.nachiamerica.com)

**Norton | Saint-Gobain Abrasives**  
**North Hall, Booth 237042**

Taking center stage at Norton | Saint-Gobain's booth at IMTS will be the Norton Xtrium range of gear solutions designed for high performance gear grinding in extreme, tight tolerance environment. The newly structured portfolio of gear grinding products is specifically designed by category to provide higher profile accuracy, supreme form holding and burn-free grinding in worm, profile and bevel applications. Highlighting the new range is an innovative dual-worm wheel design that enables two operations in one grinding wheel, substantially saving time and cost.

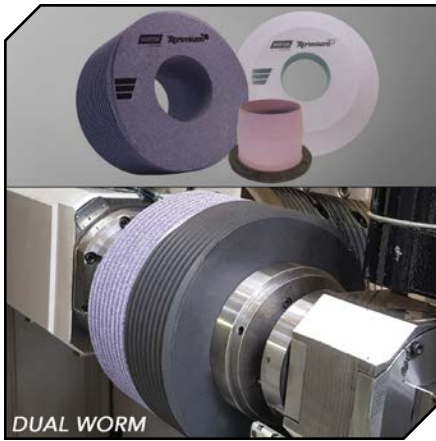

“In today’s increasingly stringent industry requirements for higher accuracy and improved surface finishes, our new high performance Xtrimium grinding wheels are engineered to deliver the highest quality gear grinding solutions,” said Jim Gaffney, senior product manager, Norton | Saint-Gobain.

Norton Xtrimium Dual-Worm grinding wheels feature a unique design with a high-performance vitrified bond section for grinding and a fine-grit resin section for polishing the gear teeth, enabling one wheel to perform what traditionally required two wheels. Substantial savings in wheel costs and productivity via the elimination of wheel swapping can be achieved with the Norton design. In addition, improved surface finishes of  $R_z = 1.0\text{mm}$  and  $R_{pk} = 0.05\text{mm}$ , and reduced harmonics (noise) are realized. The Norton Xtrimium Dual-Worm Grinding wheels can also be adapted to existing machines.

The Norton Xtrimium gear grinding platform also covers the whole range of gear grinding processes and leverages the whole spectrum of Norton grains and bond technologies to match each customer’s requirements, whether with:

Worm grinding wheels featuring micro-structured ceramic grain and providing free cutting action and wheel homogeneity, allowing constant performance throughout the wheel thickness for the life of the wheel. Superior grinding rates and increased form holding without burn are achieved with these worm grinding wheels.

Profile grinding wheels, which are ideal for deep profile gear grinding. The wheels feature high porosity and permeability, create exceptionally high material removal rates, and friction-free grinding.

Bevel grinding wheels featuring a highly porous bevel formation for extremely fast, burn-free cutting.

**For more information:**

Norton | Saint Gobain Abrasives  
Phone: (508) 795-5000  
[www.nortonabrasives.com](http://www.nortonabrasives.com)

**Oelheld  
North Hall, Booth 237475**

Oelheld will be introducing two new grinding oils. The first is the ToolGrind TC-X 620. The fluid is based on additive technology borrowed from Oelheld’s flagship SintoGrind series. ToolGrind TC-X 620 is formulated with highly refined base oils that have very good viscosity and temperature characteristics combined with low misting and aromatic content.

ToolGrind’s fortified additive package allows the oil to perform well under extreme pressure. Its active agents guarantee favorable cooling, wetting and lubrication. None of the additives contain chlorine, silicone or heavy metals and they are all non-toxic.



ToolGrind TC-X 620 promotes clean grinding wheels, low grinding temperature and less wheel wear. It prohibits work piece corrosion and is suitable for most filtration systems. The operative range covers all high speed grinding operations, such as profile, groove and surface grinding, with CBN, diamond or silicon carbide wheels. ToolGrind TC-X 620 is suitable for use with tungsten carbide, HSS, PCD, CBN, cermet and ceramics.

Oelheld is also adding the SintoGrind TC-X 630 as the new entry level product to its flagship and perennial best-selling SintoGrind series. SintoGrind TC-X 630, with its new base oil technology, will set new standards in productivity, surface finish and grinding wheel wear. The product is designed for flute grinding, profile grinding and outside and inside diameter grinding.

SintoGrind TC-X 630 works on a wide variety of materials including tungsten carbide, HSS, PCD, CBN, cermet and ceramics. SintoGrind TC-X 630 was especially formulated for demanding grinding tasks and delivers exceptional feed and speed rates with superior surface finish. Its lubricity lends to extended wheel life and minimal heat build-up, which in turn eliminates surface cracks and burns. It contains no hazardous elements and exhibits stable viscosity over a wide temperature spectrum.

Features which make both of Oelheld’s oils stand-out products include protection against cobalt leaching, low foaming, immaculate surface finish, superior aging, excellent flushing and cooling properties, low evaporation and misting, high flash point, physiologically safe composition and a pleasant odor.

**For more information:**

Oelheld U.S., Inc.  
Phone: (847) 531-8501  
[www.oelheld.com](http://www.oelheld.com)

**Penta Gear Metrology  
North Hall, Booth 237024  
See Kapp-Niles.**

**Positrol  
West Hall, Booth 431201**

Positrol’s Automation Chuck Change System enables an industrial robot to fully automate workholding changeovers. This is accomplished without the need for indicating in the chuck before beginning machining operations. The Automation Chuck Change System is designed to provide a quick change solution for not only chuck mounting, but also includes support for a power actuated drawbar as well without sacrificing rigidity. When paired with a robot, it operates as a fully automated cell where the robot not only loads and unloads parts but performs complete workholding changeovers without manual intervention. Through implementation of

quick connects for both the chuck and drawbar, multiple operations can be run across the same spindle.

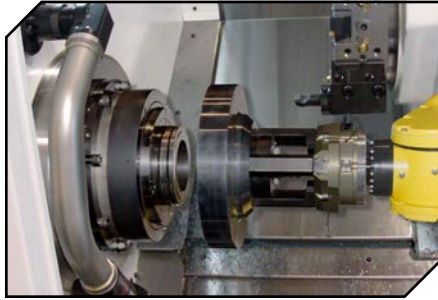

Positrol's Automation Chuck Change System can be installed on lathes, mills, balancers and gear equipment. It accommodates any drawbar and most common machine spindle sizes. Repeatability accuracy for the X, Y, and Z axes are within .0001" TIR and an angular repeatability within  $\pm 3$  arc seconds. Sealed to account for chips and other contamination, Positrol's Automation Chuck Change offers low maintenance, faster changeovers and fully automated machining capabilities.

Positrol offers a wide array of chuck and arbor designs to allow for flexibility in tailoring a workholding solution to help maximize machining efficiencies and workpiece accuracies. Positrol specializes in providing both standard and custom solutions for turning, grinding, milling, balancing, and gear operations.

Positrol's complete product line includes Pos-A-Lock collet arbors, Chuck Change systems, hydraulic membrane chucks and arbors, cartridge chucks and arbors, drawdown chucks, split diaphragm chucks, swing arm chucks, swivel-grip chucks and Superior Cincinnati collet pads and chucks.

#### For more information:

Positrol Workholding  
Phone: (513) 272-0500  
[www.positrol.com](http://www.positrol.com)

#### Reishauer

##### North Hall, Booth 237030

Reishauer offers generating grinding machines for both automotive and job shop production, as well as grinding wheels and dressing tools to support those machines.

#### For more information:

Reishauer  
Phone: (847) 888-3828  
[www.reishauer.com](http://www.reishauer.com)

#### Siemens Industry East Hall, Booth 134502; North Hall, 215004

At IMTS 2018, Siemens Industry, Inc. will present its popular Sinumerik CNC hardware and software solutions, offering dual tracks for the machine tool builder and end-user attendees from job shops and production departments of all types. Advancements in machine tool automation will be demonstrated for various CNC machines—from basic milling and turning applications to multi-axis machining centers and the fully automated, flexible work cells used throughout the manufacturing industry. In addition, Siemens will display its new Mindsphere "software as a service" concept, which enables machine tool users to gather, prioritize and access data in real-time, using edge technology.

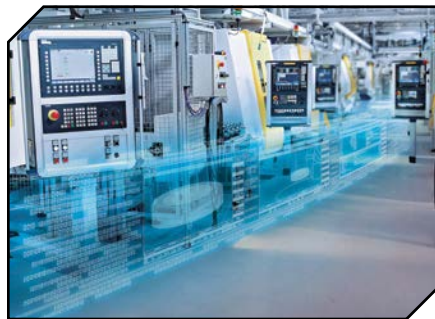

Reflecting the company's drive to the digital factory, a virtual experience for machine tool design and build functions will be presented to the OEMs, while end-users will experience how the machines used on their shop-floors will be operated, managed, programmed and maintained in the future. In combination with the advanced motion control technologies and PLM services offered by Siemens, the full process chain from CAD to CAM to virtual simulation to production and performance assessment will be on display.

#### For more information:

Siemens Industry  
Phone: (847) 640-1595  
[www.usa.siemens.com/cnc](http://www.usa.siemens.com/cnc)

#### Slater Tools

##### West Hall, Booth 432139

Slater Tools will unveil their comprehensive line-up of CNC broaching tools, toolholders and gages for complete machining and quality control over the full spectrum of shape making. In total, the company's rotary broach tools

and toolholders, punch broach tools and toolholders, and go/no-go gages represent the most comprehensive product offering of its kind available.



Rotary broaching is a highly productive method for making hex, square, serration, spline and many other specific shapes in a variety of materials on CNC machines. Slater's rotary broach tools are designed and manufactured to precision tolerances in a full range of internal and external shapes and diameters as both standards and specials—where the company can turn around custom orders in as little as one day. Multiple series of external and internal rotary broaching toolholders are offered, including adjustment-free versions, providing the needed connection between machine and tool that makes this operation so fast, economical and accurate.

Punch broaching offers excellent performance in applications where rotary broaching may not be suitable. Such instances include tough materials, greater depth of operation and/or tooth height, chip evacuation challenges and operations that require orientation. It is also beneficial for applications requiring no witness (pre-drill) marks, with excessive material removal, or where timing the form to a feature on the part is required. Keyways, hexagons, Torx-style sixlobes, serrations, splines and squares are all machined by using partial form broach tools and indexing either the tool or the workpiece, which in turn greatly reduces cutting pressure. Indexable punch broach holders facilitate the process and provide high-repeatability on CNC lathes, milling machines and presses.

"We have continued to add solutions for customers requiring products

and support over such a broad range of [shape making] applications,” says Kris Renner, Slater Tools director of operations. “There has been a continuous stream of new and custom products, including tools and holders, and now the full range of inspection gages to meet all of their needs.”

To ensure print tolerance compliance and eliminate process variations such as form size, twist and tool wear in popular shape making, Slater offers its line of standard and custom go/no-go gage sets for customer-specific applications. These gages are held to extremely tight tolerances, within .0002 inches (.005 mm), produced from oil hardened M2 high speed steel and can be custom made to any shape or size to fit customer needs. All plug and ring gages are offered for numerous shapes, either as full form composite, sector or progressive forms. Slater Tools also offers long form gage certification upon request for those applications and industries that require it.

**For more information:**

Slater Tools  
Phone: 586-465-5000  
[www.slatertools.com](http://www.slatertools.com)

**Solar Manufacturing  
North Hall, Booth 236341**

Solar Manufacturing manufactures vacuum furnaces for heat treating gears and other parts.

**For more information:**

Solar Manufacturing  
Phone: (267) 384-5040  
[solarmfg.com](http://solarmfg.com)

**Star SU  
North Hall, Booth 236909; West Hall,  
Booth 432258**

The Star SU team of product and technology experts will be available at two booth locations — one in the gear pavilion in the North Hall and another in the West Hall showcasing their cutting tool technology.



The North Hall booth in the Gear Pavilion will feature two machines: The FFG Modul H200 vertical gear hobbing machine and the new Star NXT tool grinder. They will also have video demonstrations of their latest grinding advancements, including the Samputensili SG 160 Sky Grind, the first gear dry grinding machine in the world. The G-160 wet grinding head will also be on display. Additionally, visitors will be able to view Star SU's enhanced interactive customer solution tool for Star SU's full line of machine tool, cutting tool and tool services from the brands they represent including Star Cutter Company, Samputensili, FFG Werke (Modul and Hessapp) and H.B. Carbide.

The centerpiece of Star SU's display, the Star NXT Tool Grinder, was designed with big machine capabilities and small machine footprint. Star SU intends for this revolutionary design to be the new standard.

Star's latest CNC 5-axis tool grinder is built with the purpose of meeting and exceeding what the market demands: a versatile tool grinder with less moving parts and a small footprint, a large grind zone, the ability to run small and large diameter wheels, with easily configurable options, a modular design, and a competitive price point.

The NXT fuses the best aspects of Star SU's current product line into a next generation machine that offers benefits of smaller size, greater diversity, increased capability, flexibility, durability and added value.

Features include a focused design to deliver a maximized grind zone with a small footprint of 2 meters wide, the smallest footprint to work envelope ratio on the market, 28kW synchronous spindle @20,000 rpm, up to 250 mm diameter tools, Fanuc robot automation with 3-38 mm gripper assembly and NUMROTOplus: the best grinding software worldwide. The NXT is engineered with the latest in linear and rotary torque motor technology to eliminate backlash, friction effects and drive vibration. Application support is available to train operators and manufacture all of your complex tools. The NXT is designed, manufactured and serviced in the USA.

Star SU will also be showing off the FFG Werke Modul H200 vertical

hobbing machine. The H 80-200 series is the latest version of the company's hobbing machine line for automotive as well as Job Shop applications. The optional automatic high-speed part changer is especially engineered for automotive applications with less than two seconds chip-to-chip time. These machines have been designed for dry cutting applications in particular, although using oil or emulsion is not a problem. Chips are conveyed immediately from the work area by means of steep and smooth stainless steel glad chutes to prevent any build up. The hob head is housed within the tool column, which is tightly fastened to the sturdy machine bed. The CNC tailstock is located on the counter column and cross bar above the hob head, leaving the work area remarkably free for workpiece loading and unloading operations. Request a budget quote and plan to see it at IMTS by visiting Star SU's H 80-200 vertical gear hobbing machine webpage.



Star SU will also show a wide variety of gear cutting tools, precision tool re-sharpening services and advanced coatings from Oerlikon Balzers, including Alcrona Pro and Balanit Altensa, the high-speed coating solution that realizes productivity gains and efficiency. Star SU will also feature their highly coveted Scudding cutters manufactured to produce gear and spline teeth for reduced cycle times and tool costs.

Star SU also welcomes visitors to join them at their West Hall tooling booth to see their complete offerings from their technology partners, including Star Cutter Company, Samputensili, Neher, 5ME and H.B. Carbide.

Star SU carries a full line of gundrills and deep hole drilling solutions, including single flute gundrills, solid carbide single flute gundrills, two-flute two-hole gundrills, double jet gundrills, double



crimp gundrills, deep hole twist drills, rifle buttons pull reamers and push reamers. Come by and let Star SU design and build a gundrill solution for you.

Star SU also offers a wide range of precision solid carbide drills and reamers, including solid and braze construction carbide drills and reamers; core drills; Super Round Tool (SRT) reamers; valve guide reamers and multi diameter cavity machining tools.

Also on display: 5ME cryogenic machining combined with Star SU BlueZone ventilated end mills, tapered ball mills, reamers and drills, designed to create a more profitable and efficient manufacturing experience by reducing the cutting temperature, using liquid nitrogen, to -321°F.

Star SU/Neher produces high performance PCD tools that are engineered to customer requirements. Their wide range of PCD products include circular milling tools, face milling tools, combination tools, counterbore tools, precision reamer/multi-step reamers and PCD drills. Their PCD products can be applied to all types of non-ferrous materials.

Finally, Star SU offers a wide variety of tungsten carbide blanks and preforms from H.B. Carbide. Using only the highest quality raw materials and employing state-of-the-art, computer controlled vacuum Sinter-Hipping furnaces, these cemented carbide preforms can be used for cutting tools, dies and wear parts in a variety of specialized applications.

#### For more information:

Star SU LLC  
Phone: (847) 649-1450  
[www.star-su.com](http://www.star-su.com)

### Suhner

#### West Hall, Booth 431474

Suhner Industrial Products now offers robot solutions for fully-automated manufacturing. The new quick change tool system offers a number of powerful machine tools that can be mounted directly on the robot arm and be ready for continuous use.



The Suhner power-pack robot machine tools are compatible with all robot manufacturers, making them versatile for demanding high-performance applications. The tools feature programmable touch forces of the active flange and interactive surface tracking. This allows operations that were previously not suitable for automation to now be automated. Other features include programmable process forces, balanced tolerances (shapes) and reduced programming time and effort for complex parts. Performance and process assurance compared to known systems, such as load cells, can be drastically increased.

Tools are available for brushing, polishing, filing, belt sanding or tool spindles, and are easily integrated.



Applications for the new robot tools range from automotive manufacturing to deburring operations, stainless steel machining to drilling and tapping operations, and all areas of manufacturing and operations.

Suhner worked in cooperation with Ferrobotics, world leader in development of flexible, intuitive robotic equipment to develop the equipment.

#### For more information:

Suhner Industrial Products Corporation  
Phone: (706) 235-8046  
[www.suhner.com](http://www.suhner.com)

### Toyoda Americas

#### South Hall, Booth 338519

Combining lean thinking with cutting edge solutions, JTEKT Toyoda Americas Corporation plans to unveil 6 new machines of their 15 featured during IMTS 2018. Toyoda's anchored position in the South Hall will exhibit live machine tools, automation, IoT solutions and innovative presentations. New machine exhibits include a 5-axis VMC for titanium machining, universal grinding machines with adjustable wheelhead, a multipurpose turning center with twin

turret and twin spindle and a production type machine for gear manufacturing.

Coming off Toyota's GS300H win at the 2017 Automotive News PACE Awards for its high-speed synchronization technology, Toyota recently released its compact sibling, the GS200H, targeting high production lines. Offering improved productivity and flexible machining by integrating gear part processes of a lathe, gear skiving and machining center capabilities in one.

Making its United States debut, the Takisawa Taiwan MX-800 multi-purpose turning center, is built for process integration and high productivity. Standard with heavy duty twin upper T15 turrets, built-in twin spindle and twin Y-axis, 2" bar capacity (up to 2.5") and 8" chucks.

Among new product releases are Toyoda's latest production advancements in pursuit of the most efficient machining methods. Revolutionizing shop floors into smart factories, Toyoda takes the fundamental approach of IoT combined with their rich automotive production history to encompass what they call IoE (Internet of Everything). IoE encompasses connectivity, data transmission and analytics of both people and machine — all fundamentals of Toyota's "Andon" system.

Toyoda's smart manufacturing product initiatives include connectivity solutions Toyopuc Plus and Nano PLCs, visualization solutions Machine Metrics, Toyopuc Touch HMI and Signal Hop, and value solution Toyopuc Touch AAA.

#### For more information:

Toyoda Americas Corporation  
Phone: (847) 253-0340  
[www.toyoda.com](http://www.toyoda.com)

### Wenzel America

#### East Hall, Booth 135622

Wenzel America are showing three new products at IMTS for the first time in North America. These three products represent each of the company's three hardware product specialties: metrology, high-speed optical scanning and computed tomography (CT).

The new SF 87 coordinate measuring machine is the ideal entry-level unit for any manufacturing environment. Its use of temperature compensation, dirt resistant guides and optional active damping make it ideal for locating alongside cutting and forming machines on the

shop floor. It has a measuring volume of 800×700×700 [mm], which is optimal in relation to its small footprint and has available the full range of Renishaw probing systems as well as Wenzel's laser and structured light sensor options. Its ridged cantilever design enables it to have high traversing speeds and acceleration to ensure high productivity and, best of all for some, it has a tremendously competitive price performance ratio.

Also on display in the Wenzel Booth is the latest version of the highly successful Wenzel Core-D high-speed optical scanning machine that is widely used for measuring polished turbine blades and medical implants. The unique feature of the Core machine is that despite being an optical system, its unique double-eye spot sensor can measure even highly polished surfaces without the need to coat the parts to dull reflection. Many optical systems are claimed to be able to scan "shiny" surfaces but the Core will measure polished or recently machined metal and the surfaces never need to be sprayed. Features of the new machine include enhanced environmental protection from temperature variation and shop floor dirt as well as a greater capability to integrate with automation. The latest version also makes available a structured light sensor for collecting point clouds in addition to the Core's unique double-eye spot sensor.

IMTS sees the North American launch of the exaCT S90 High resolution micro CT machine which will be scanning parts live at the show. This is the first exaCT S machine to utilize GPU processing power for reconstruction which in combination with state of the art detector allows unprecedented scanning and reconstruction speed. The ideal size of parts targeted by the exaCT S range from a pin-head to a hockey puck and it is particularly suited to micro-machined and molded medical device parts and implants.

**For more information:**  
Wenzel America, Ltd.  
Phone: (248) 295-4300  
[www.wenzelamerica.com](http://www.wenzelamerica.com)

## Zoller West Hall, Booth 432018

As a long-standing exhibitor at IMTS, Zoller knows that the technology and innovations on display at IMTS are shaping the future of the manufacturing industry. Zoller is committed to bringing the most efficient processes to the U.S. market as they have done since 1997.



In today's ever changing production environment, how do companies of all sizes go about meeting increasingly rigid quality standards faster while simultaneously saving money? The answer is simple: Zoller *Smart Factory Solutions*. To start, companies need to know that the tooling data they are working with is consistent across their facility.

With transparent data transfer between the Zoller *TMS Tool Management Solutions* software and CAM software, manufacturers can ensure that their 3D tooling models are produced correctly. Thanks to the central »z.One« tool database, tooling data remains consistent, regardless of who is accessing it. From the CAM software, Zoller solutions aim to focus on optimizing tool storage, organization and management next by integrating powerful *TMS* software with the extraordinary new Zoller Smart Cabinets.

With Zoller's *TMS* in conjunction with Zoller Smart Cabinets, each tool storage cabinet can be designed and graphically displayed in the software, and single components, tool assemblies and accessories can be tracked down to the individual compartment of the specific drawer and cabinet in which it's stored. Time spent looking for tools is eliminated, as Smart Cabinets provide total tooling control.

Zoller's solution doesn't stop there. Thanks to Zoller's user-friendly »pilot

3.0« operating software, measuring the most complex tool geometries is a simple task. With Zoller's tool presetting solutions, setup times are drastically reduced, while spindle up-time is increased. Companies are able to preset tools for upcoming jobs while current jobs are running, and they have the insurance of knowing that their first part is the right part, every time. This helps significantly reduce scrap and waste in manufacturing. With data output, tool offset information can be directly communicated to the machine control, eliminating potential human-error in data transfer.

At IMTS 2018, these integrated Smart Factory solutions from Zoller will be demonstrated live at their booth in one cohesive product demonstration called 'Art-to-Part.' Visitors will see how Zoller solutions tie together to make smart, connected manufacturing a reality today.

Manufacturers globally have been benefitting from Zoller's easy to use manufacturing solutions for over 70 years. Building a tool database can take time, but Zoller is there to assist in the database development process and make the transition as smooth as possible.

Zoller is committed to providing solutions to an increasingly demanding manufacturing environment. In partnering with Zoller, companies get to experience how Zoller's smart factory solutions are tailored for the challenges of Industry 4.0 they are facing currently, while concurrently feeling the security of knowing that Zoller will be there to work with them as they tackle the manufacturing challenges of the future.

**For more information:**  
Zoller Inc.  
Phone: (734) 332-4851  
[www.zoller-usa.com](http://www.zoller-usa.com)

For Related Articles Search

IMTS

at [www.geartechnology.com](http://www.geartechnology.com)